

# Electrical Conduit

Construction Electricity Wiring System



Everything we do is for the perfection of electric wiring



JORGE ALBERTO RIOS  
BLVD. ALFONSO ZARAGOZA MAYTORENA #1980  
DESARROLLO URBANO TRES RÍOS CULIACÁN, SINALOA  
(667) 207 7777  
DIRECCION@DUCTOSAISLADOS.COM  
WWW.DUCMEX.COM

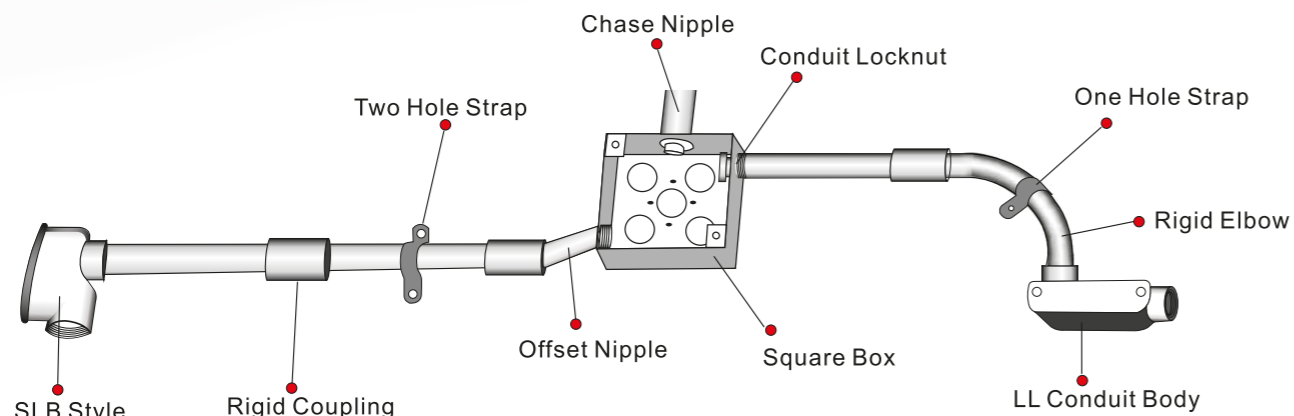

## Steel Conduit & Fittings

- EMT Conduit, IMC Conduit, Rigid Steel Conduit
- EMT Connectors and Couplings
- IMC Conduit, Rigid Steel Conduit Fittings
- Other Fittings for EMT Rigid Conduit
- Conduit Body, Weatherproof Box
- Steel Boxes and Covers
- Earthing Rods and Meter Socket

## Flexible Conduit & Fittings

- Flexible Steel Conduit
- PVC Coated Flexible Conduit
- Liquid Tight Conduit
- Corrugated Flexible Conduit
- Liquid Tight & Squeeze Connector
- Other Connector

## Strut Channel & Fittings

- Unistrut Channel
- Thread Rods and Hardware
- Strut Clamp, Conduit Hanger
- Clevis Hanger and Loop Hanger
- Beam Clamp and Other Fittings

## Electrical Conduit Tools

- Conduit Bender
- Fish Wire Tape, Cable Puller
- PVC Bending Spring
- Cable Glands
- Terminal Blocks
- Cable Ties, Insulator

## EMT Conduit Pipe Accord to ANSI C80.3, UL797

### Dimensions for Standard

Finish: Pre-galvanized  
Hot dip galvanized(UL Listed)

| Trade Size Designator |        | Nominal Outside Dia. |        | Nominal Wall Thickness |      | Two Length |      |
|-----------------------|--------|----------------------|--------|------------------------|------|------------|------|
| U.S.                  | Metric | in.                  | mm     | in.                    | mm   | mm         | mm   |
| 1/2"                  | 16     | 0.706                | 17.93  | 0.042                  | 1.07 | 3000       | 3050 |
| 3/4"                  | 21     | 0.922                | 23.42  | 0.049                  | 1.24 | 3000       | 3050 |
| 1"                    | 27     | 1.163                | 29.54  | 0.057                  | 1.45 | 3000       | 3050 |
| 1 1/4"                | 35     | 1.510                | 38.35  | 0.065                  | 1.65 | 3000       | 3050 |
| 1 1/2"                | 41     | 1.740                | 44.20  | 0.065                  | 1.65 | 3000       | 3050 |
| 2"                    | 53     | 2.197                | 55.80  | 0.065                  | 1.65 | 3000       | 3050 |
| 2 1/2"                | 63     | 2.875                | 73.03  | 0.072                  | 1.83 | 3000       | 3050 |
| 3"                    | 78     | 3.500                | 88.90  | 0.072                  | 1.83 | 3000       | 3050 |
| 3 1/2"                | 91     | 4.000                | 101.60 | 0.083                  | 2.11 | 3000       | 3050 |
| 4"                    | 103    | 4.500                | 114.30 | 0.083                  | 2.11 | 3000       | 3050 |



### Dimensions for Thinwall Thickness

Finish: Pre-galvanized

| Trade Size Designator |        | Nominal Outside Dia. |       | Nominal Wall Thickness |      | Two Length |      |
|-----------------------|--------|----------------------|-------|------------------------|------|------------|------|
| U.S.                  | Metric | in.                  | mm    | in.                    | mm   | mm         | mm   |
| 1/2"                  | 16     | 0.706                | 17.93 | 0.031                  | 0.80 | 3000       | 3050 |
| 3/4"                  | 21     | 0.922                | 23.42 | 0.035                  | 0.90 | 3000       | 3050 |
| 1"                    | 27     | 1.163                | 29.54 | 0.039                  | 1.00 | 3000       | 3050 |
| 1 1/4"                | 35     | 1.510                | 38.35 | 0.051                  | 1.30 | 3000       | 3050 |
| 1 1/2"                | 41     | 1.740                | 44.20 | 0.051                  | 1.30 | 3000       | 3050 |
| 2"                    | 53     | 2.197                | 55.80 | 0.055                  | 1.40 | 3000       | 3050 |

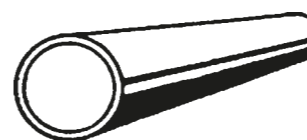

Note: All information available at the time of order  
If you need other thickness or length pls contact us.

### EMT Elbows

Finish: Pre-galvanized  
Hot dip galvanized(UL Listed)

| Cat.No. | Cat.No. | Size   |
|---------|---------|--------|
| 8300    | 8310    | 1/2"   |
| 8301    | 8311    | 3/4"   |
| 8302    | 8312    | 1"     |
| 8303    | 8313    | 1 1/4" |
| 8304    | 8314    | 1 1/2" |
| 8305    | 8315    | 2"     |
| 8306    | 8316    | 2 1/2" |
| 8307    | 8317    | 3"     |
| 8308    | 8318    | 3 1/2" |
| 8309    | 8319    | 4"     |

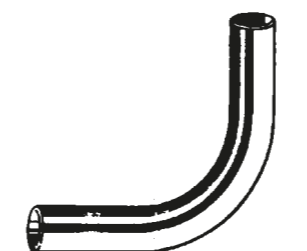

## IMC Conduit Pipe

### Accord to ANSI C80.6, UL 1242

Dimensions for Standard  
Finish: Hot dip galvanized

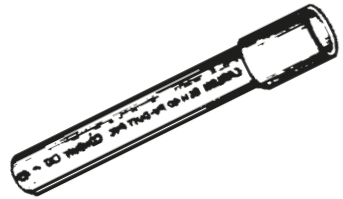

| Trade Size Designator |        | Nominal Outside Dia. |        | Nominal Wall Thickness |      | Length |      |
|-----------------------|--------|----------------------|--------|------------------------|------|--------|------|
| U.S.                  | Metric | in.                  | mm     | in.                    | mm   | ft.    | mm   |
| 1/2"                  | 16     | 0.815                | 20.70  | 0.078                  | 1.98 | 10     | 3000 |
| 3/4"                  | 21     | 1.029                | 26.10  | 0.083                  | 2.10 | 10     | 3000 |
| 1"                    | 27     | 1.290                | 32.77  | 0.093                  | 2.35 | 10     | 3000 |
| 1 1/4"                | 35     | 1.638                | 41.59  | 0.095                  | 2.42 | 10     | 3000 |
| 1 1/2"                | 41     | 1.883                | 47.82  | 0.100                  | 2.54 | 10     | 3000 |
| 2"                    | 53     | 2.360                | 59.93  | 0.105                  | 2.67 | 10     | 3000 |
| 2 1/2"                | 63     | 2.857                | 72.57  | 0.150                  | 3.81 | 10     | 3000 |
| 3"                    | 78     | 3.476                | 88.29  | 0.150                  | 3.81 | 10     | 3000 |
| 3 1/2"                | 91     | 3.971                | 100.86 | 0.150                  | 3.81 | 10     | 3000 |
| 4"                    | 103    | 4.466                | 113.44 | 0.150                  | 3.81 | 10     | 3000 |

## Rigid Steel Conduit

### Accord to ANSI C80.1, UL6

Dimensions for Standard  
Finish: Hot dip galvanized

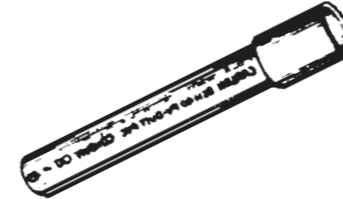

| Trade Size Designator |        | Nominal Outside Dia. |        | Nominal Wall Thickness |      | Length |      |
|-----------------------|--------|----------------------|--------|------------------------|------|--------|------|
| U.S.                  | Metric | in.                  | mm     | in.                    | mm   | ft.    | mm   |
| 1/2"                  | 16     | 0.840                | 21.34  | 0.104                  | 2.64 | 10     | 3000 |
| 3/4"                  | 21     | 1.050                | 26.67  | 0.107                  | 2.72 | 10     | 3000 |
| 1"                    | 27     | 1.315                | 33.40  | 0.126                  | 3.20 | 10     | 3000 |
| 1 1/4"                | 35     | 1.660                | 42.16  | 0.133                  | 3.38 | 10     | 3000 |
| 1 1/2"                | 41     | 1.900                | 48.26  | 0.138                  | 3.51 | 10     | 3000 |
| 2"                    | 53     | 2.375                | 60.33  | 0.146                  | 3.71 | 10     | 3000 |
| 2 1/2"                | 63     | 2.875                | 73.03  | 0.193                  | 4.90 | 10     | 3000 |
| 3"                    | 78     | 3.500                | 88.90  | 0.205                  | 5.21 | 10     | 3000 |
| 3 1/2"                | 91     | 4.000                | 101.60 | 0.215                  | 5.46 | 10     | 3000 |
| 4"                    | 103    | 4.500                | 114.30 | 0.225                  | 5.72 | 10     | 3000 |
| 5"                    | 129    | 5.563                | 141.30 | 0.245                  | 6.22 | 10     | 3000 |
| 6"                    | 155    | 6.625                | 168.30 | 0.266                  | 6.76 | 10     | 3000 |

### Dimensions for Thinwall Thickness

Finish: Pre-galvanized

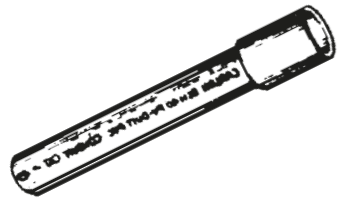

| Trade Size Designator |        | Nominal Outside Dia. |       | Thinner Wall Thickness |      | Two Length |      |
|-----------------------|--------|----------------------|-------|------------------------|------|------------|------|
| U.S.                  | Metric | in.                  | mm    | mm                     | mm   | mm         | mm   |
| 1/2"                  | 16     | 0.815                | 20.70 | 1.79                   | 1.45 | 3000       | 3050 |
| 3/4"                  | 21     | 1.029                | 26.10 | 1.90                   | 1.45 | 3000       | 3050 |
| 1"                    | 27     | 1.290                | 32.77 | 2.15                   | 1.80 | 3000       | 3050 |
| 1 1/4"                | 35     | 1.638                | 41.59 | 2.16                   | 2.00 | 3000       | 3050 |
| 1 1/2"                | 41     | 1.883                | 47.82 | 2.29                   | 2.00 | 3000       | 3050 |
| 2"                    | 53     | 2.360                | 59.93 | 2.41                   | 2.00 | 3000       | 3050 |

Note: All information available at the time of order  
If you need other thickness or length pls contact us.

### Rigid Conduit Elbows

Finish: Hot dip galvanized

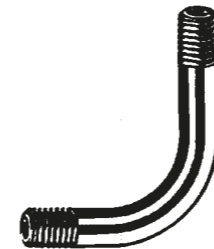

| Cat.No. | Cat.No. | Size   |
|---------|---------|--------|
| 90°     | 45°     |        |
| 8344    | 8356    | 1/2"   |
| 8345    | 8357    | 3/4"   |
| 8346    | 8358    | 1"     |
| 8347    | 8359    | 1 1/4" |
| 8348    | 8360    | 1 1/2" |
| 8349    | 8361    | 2"     |
| 8350    | 8362    | 2 1/2" |
| 8351    | 8363    | 3"     |
| 8352    | 8364    | 3 1/2" |
| 8353    | 8365    | 4"     |
| 8354    | 8366    | 5"     |
| 8355    | 8367    | 6"     |

### Rigid Conduit Coupling

Finish: Electro-galvanized

Hot dip galvanized

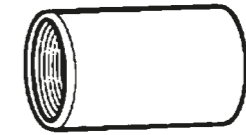

| Cat.No. | Size   |
|---------|--------|
| 0324    | 1/2"   |
| 0325    | 3/4"   |
| 0326    | 1"     |
| 0327    | 1 1/4" |
| 0328    | 1 1/2" |
| 0329    | 2"     |
| 0330    | 2 1/2" |
| 0331    | 3"     |
| 0332    | 3 1/2" |
| 0333    | 4"     |
| 0334    | 5"     |
| 0335    | 6"     |

### IMC Elbows

Finish: Pre-galvanized  
Hot dip galvanized(UL Listed)

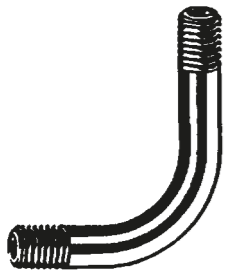

| Cat.No. | Size   |
|---------|--------|
| 90°     |        |
| 8320    | 1/2"   |
| 8321    | 3/4"   |
| 8322    | 1"     |
| 8323    | 1 1/4" |
| 8324    | 1 1/2" |
| 8325    | 2"     |
| 8326    | 2 1/2" |
| 8327    | 3"     |
| 8328    | 3 1/2" |
| 8329    | 4"     |

### IMC Coupling

Finish: Electro-galvanized  
Hot dip galvanized

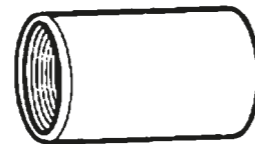

| Cat.No. | Size   |
|---------|--------|
| IC-050  | 1/2"   |
| IC-075  | 3/4"   |
| IC-100  | 1"     |
| IC-125  | 1 1/4" |
| IC-150  | 1 1/2" |
| IC-200  | 2"     |
| IC-250  | 2 1/2" |
| IC-300  | 3"     |
| IC-350  | 3 1/2" |
| IC-400  | 4"     |





## EMT Conduit Fittings

### EMT Set Screw Connectors-Zinc

- Use to Terminate EMT Pipe to Box

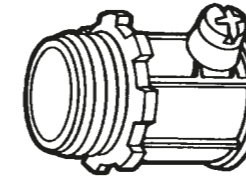

| Cat.No.       | Cat.No.   | Conduit Size |
|---------------|-----------|--------------|
| Non-Insulated |           | Insulated    |
| SSCN-050      | SSCN-050I | 1/2"         |
| SSCN-075      | SSCN-075I | 3/4"         |
| SSCN-100      | SSCN-100I | 1"           |
| SSCN-125      | SSCN-125I | 1 1/4"       |
| SSCN-150      | SSCN-150I | 1 1/2"       |
| SSCN-200      | SSCN-200I | 2"           |
| SSCN-250      | SSCN-250I | 2 1/2"       |
| SSCN-300      | SSCN-300I | 3"           |
| SSCN-400      | SSCN-400I | 4"           |

### EMT Set Screw Couplings-Zinc

- Use to Couple two ends of EMT Pipe

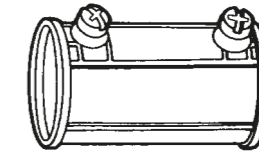

| Cat.No.  | Conduit Size |
|----------|--------------|
| SSCP-050 | 1/2"         |
| SSCP-075 | 3/4"         |
| SSCP-100 | 1"           |
| SSCP-125 | 1 1/4"       |
| SSCP-150 | 1 1/2"       |
| SSCP-200 | 2"           |
| SSCP-250 | 2 1/2"       |
| SSCP-300 | 3"           |
| SSCP-400 | 4"           |

### EMT Compression Connectors-Zinc

- Use to Terminate EMT Pipe to Box

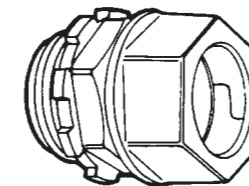

| Cat.No.       | Cat.No.  | Conduit Size |
|---------------|----------|--------------|
| Non-Insulated |          | Insulated    |
| CCN-050       | CCN-050I | 1/2"         |
| CCN-075       | CCN-075I | 3/4"         |
| CCN-100       | CCN-100I | 1"           |
| CCN-125       | CCN-125I | 1 1/4"       |
| CCN-150       | CCN-150I | 1 1/2"       |
| CCN-200       | CCN-200I | 2"           |

### EMT Compression Couplings-Zinc

- Use to Couple two ends of EMT Pipe

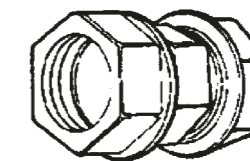

| Cat.No. | Conduit Size |
|---------|--------------|
| CCP-050 | 1/2"         |
| CCP-075 | 3/4"         |
| CCP-100 | 1"           |
| CCP-125 | 1 1/4"       |
| CCP-150 | 1 1/2"       |
| CCP-200 | 2"           |

### EMT Set Screw Connectors-Aluminum

- Use to Terminate EMT Pipe to Box

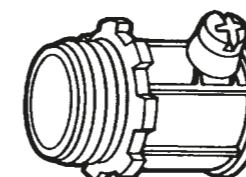

| Cat.No.       | Cat.No.    | Conduit Size |
|---------------|------------|--------------|
| Non-Insulated |            | Insulated    |
| SSCN-050A     | SSCN-050AI | 1/2"         |
| SSCN-075A     | SSCN-075AI | 3/4"         |
| SSCN-100A     | SSCN-100AI | 1"           |
| SSCN-125A     | SSCN-125AI | 1 1/4"       |
| SSCN-150A     | SSCN-150AI | 1 1/2"       |
| SSCN-200A     | SSCN-200AI | 2"           |

### EMT Set Screw Couplings-Aluminum

- Use to Couple two ends of EMT Pipe

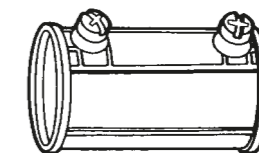

| Cat.No.   | Conduit Size |
|-----------|--------------|
| SSCP-050A | 1/2"         |
| SSCP-075A | 3/4"         |
| SSCP-100A | 1"           |
| SSCP-125A | 1 1/4"       |
| SSCP-150A | 1 1/2"       |
| SSCP-200A | 2"           |

## EMT Conduit Fittings

### EMT Set Screw Connectors-Steel

- Use to Terminate EMT Pipe to Box

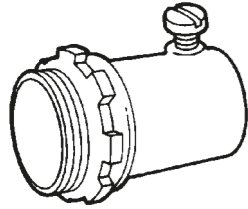

| Cat.No.       | Cat.No. | Conduit Size |
|---------------|---------|--------------|
| Non-Insulated |         |              |
| H-50S         | H-50SI  | 1/2"         |
| H-75S         | H-75SI  | 3/4"         |
| H-100S        | H-100SI | 1"           |
| H-125S        | H-125SI | 1 1/4"       |
| H-150S        | H-150SI | 1 1/2"       |
| H-200S        | H-200SI | 2"           |
| H-250S        | H-250SI | 2 1/2"       |
| H-300S        | H-300SI | 3"           |
| H-350S        | H-350SI | 3 1/2"       |
| H-400S        | H-400SI | 4"           |

### EMT Set Screw Couplings-Steel

- Use to Couple two ends of EMT Pipe

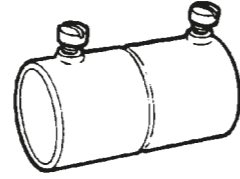

| Cat.No. | Conduit Size |
|---------|--------------|
| Z-50S   | 1/2"         |
| Z-75S   | 3/4"         |
| Z-100S  | 1"           |
| Z-125S  | 1 1/4"       |
| Z-150S  | 1 1/2"       |
| Z-200S  | 2"           |
| Z-250S  | 2 1/2"       |
| Z-300S  | 3"           |
| Z-350S  | 3 1/2"       |
| Z-400S  | 4"           |

### EMT Compression Connectors-Steel

- Use to Terminate EMT Pipe to Box

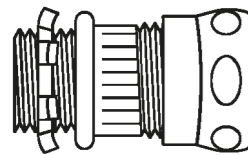

| Cat.No.       | Cat.No.  | Conduit Size |
|---------------|----------|--------------|
| Non-Insulated |          |              |
| ZC-50S        | ZC-50SI  | 1/2"         |
| ZC-75S        | ZC-75SI  | 3/4"         |
| ZC-100S       | ZC-100SI | 1"           |
| ZC-125S       | ZC-125SI | 1 1/4"       |
| ZC-150S       | ZC-150SI | 1 1/2"       |
| ZC-200S       | ZC-200SI | 2"           |
| ZC-250S       | ZC-250SI | 2 1/2"       |
| ZC-300S       | ZC-300SI | 3"           |
| ZC-350S       | ZC-350SI | 3 1/2"       |
| ZC-400S       | ZC-400SI | 4"           |

### EMT Compression Couplings-Steel

- Use to Couple two ends of EMT Pipe

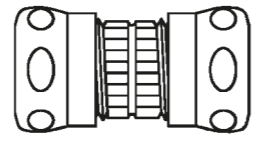

| Cat.No.  | Conduit Size |
|----------|--------------|
| ZCC-50S  | 1/2"         |
| ZCC-75S  | 3/4"         |
| ZCC-100S | 1"           |
| ZCC-125S | 1 1/4"       |
| ZCC-150S | 1 1/2"       |
| ZCC-200S | 2"           |
| ZCC-250S | 2 1/2"       |
| ZCC-300S | 3"           |
| ZCC-350S | 3 1/2"       |
| ZCC-400S | 4"           |

### EMT Capped Corner Couplings-Zinc

- EMT Pipe to EMT Pipe

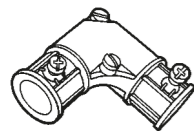

| Cat.No. | Conduit Size |
|---------|--------------|
| CCC-050 | 1/2"         |
| CCC-075 | 3/4"         |

### EMT Connector Set Screw Type 90° -Zinc

- EMT Pipe to Box when 90 degree turns

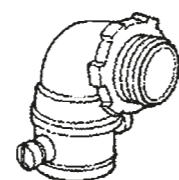

| Cat.No.  | Conduit Size |
|----------|--------------|
| ECSS-075 | 3/4"         |
| ECSS-100 | 1"           |
| ECSS-125 | 1 1/4"       |

## Steel Conduit Fittings

### Watertight Hubs

- With insulated throat

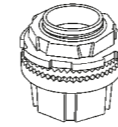

Zinc

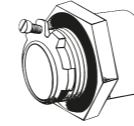

Malleable



| Cat.No. | Cat.No.   | Conduit Size |
|---------|-----------|--------------|
| Zinc    | Malleable |              |
| H-050   | H-050M    | 1/2"         |
| H-075   | H-075M    | 3/4"         |
| H-100   | H-100M    | 1"           |
| H-125   | H-125M    | 1 1/4"       |
| H-150   | H-150M    | 1 1/2"       |
| H-200   | H-200M    | 2"           |
| H-250   | H-250M    | 2 1/2"       |
| H-300   | H-300M    | 3"           |
| H-400   | H-400M    | 4"           |
| -       | H-500M    | 5"           |
| -       | H-600M    | 6"           |

### EMT Pull Corner Elbows-Zinc

- EMT Pipe to EMT Pipe

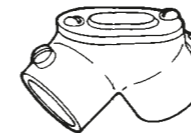

| Cat.No. | Conduit Size |
|---------|--------------|
| ETE-050 | 1/2"         |
| ETE-075 | 3/4"         |
| ETE-100 | 1"           |

### Pull Corner Elbows-Zinc

- EMT Pipe to Box

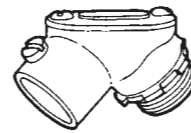

| Cat.No. | Conduit Size |
|---------|--------------|
| ETB-050 | 1/2"         |
| ETB-075 | 3/4"         |
| ETB-100 | 1"           |

### Pull Corner Elbows-Zinc

- Rigid Conduit to Rigid Conduit

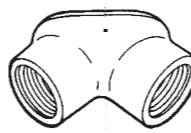

| Cat.No. | Conduit Size |
|---------|--------------|
| RTR-050 | 1/2"         |
| RTR-075 | 3/4"         |
| RTR-100 | 1"           |

### Pull Corner Elbows-Zinc

- Rigid Conduit to Box



| Cat.No. | Conduit Size |
|---------|--------------|
| RTB-050 | 1/2"         |
| RTB-075 | 3/4"         |
| RTB-100 | 1"           |

### Reducing Bushings

- Steel

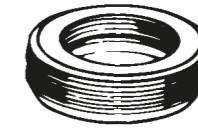

| Cat.No.   | Conduit Size    |
|-----------|-----------------|
| RB-075050 | 3/4" x 1/2"     |
| RB-100050 | 1" x 1/2"       |
| RB-100075 | 1" x 3/4"       |
| RB-125050 | 1 1/4" x 1/2"   |
| RB-125075 | 1 1/4" x 3/4"   |
| RB-125100 | 1 1/4" x 1"     |
| RB-150050 | 1 1/2" x 1/2"   |
| RB-150075 | 1 1/2" x 3/4"   |
| RB-150100 | 1 1/2" x 1"     |
| RB-150125 | 1 1/2" x 1 1/4" |
| RB-200050 | 2" x 1/2"       |
| RB-200075 | 2" x 3/4"       |
| RB-200100 | 2" x 1"         |
| RB-200125 | 2" x 1 1/4"     |
| RB-200150 | 2" x 1 1/2"     |

### Rigid Male Enlarger-Malleable Iron

- Adapt an outlet hole to next large size

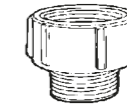

| Cat.No.   | Conduit Size    |
|-----------|-----------------|
| RME-5075  | 1/2" M x 3/4" F |
| RME-75100 | 3/4" M x 1" F   |

### Rigid Male Enlarger-Steel

- Adapt an outlet hole to next large size

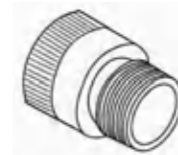

| Cat.No.   | Conduit Size    |
|-----------|-----------------|
| ME-050075 | 1/2" M x 3/4" F |
| ME-050100 | 1/2" M x 1" F   |
| ME-075100 | 3/4" M x 1" F   |
| ME-100125 | 1" M x 1 1/4" F |

### EMT Combination Couplings-Zinc

- EMT Pipe to Flex

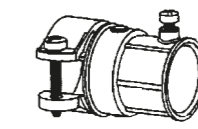

| Cat.No. | Conduit Size |
|---------|--------------|
| ESC-050 | 1/2"         |
| ESC-075 | 3/4"         |
| ESC-100 | 1"           |

### EMT Offset Connectors-Zinc

- EMT Pipe to Box

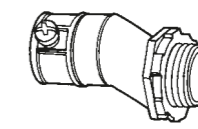

| Cat.No. | Conduit Size |
|---------|--------------|
| OFC-050 | 1/2"         |
| OFC-075 | 3/4"         |
| OFC-100 | 1"           |

## Rigid Conduit Fittings

### Rigid Set Screw Connectors-Steel

- Use to Terminate IMC/Rigid Pipe to Box

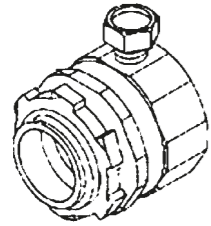

| Cat.No.   | Conduit Size |
|-----------|--------------|
| SSCN-050R | 1/2"         |
| SSCN-075R | 3/4"         |
| SSCN-100R | 1"           |
| SSCN-125R | 1 1/4"       |
| SSCN-150R | 1 1/2"       |
| SSCN-200R | 2"           |

### Rigid Set Screw Couplings-Steel

- Use to Couple two ends of IMC/Rigid Pipe

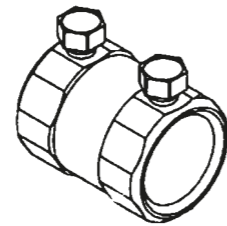

| Cat.No.   | Conduit Size |
|-----------|--------------|
| SSCP-050R | 1/2"         |
| SSCP-075R | 3/4"         |
| SSCP-100R | 1"           |
| SSCP-125R | 1 1/4"       |
| SSCP-150R | 1 1/2"       |
| SSCP-200R | 2"           |

### Rigid Compression Connectors-Steel

- Use to Terminate IMC/Rigid Pipe to Box

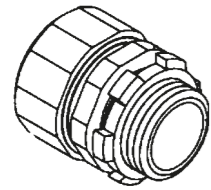

| Cat.No. | Conduit Size |
|---------|--------------|
| Y-RT50  | 1/2"         |
| Y-RT75  | 3/4"         |
| Y-RT100 | 1"           |
| Y-RT125 | 1 1/4"       |
| Y-RT150 | 1 1/2"       |
| Y-RT200 | 2"           |

### Rigid Compression Couplings-Steel

- Use to Couple two ends of IMC/Rigid Pipe

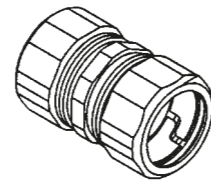

| Cat.No.  | Conduit Size |
|----------|--------------|
| Y-RTC50  | 1/2"         |
| Y-RTC75  | 3/4"         |
| Y-RTC100 | 1"           |
| Y-RTC125 | 1 1/4"       |
| Y-RTC150 | 1 1/2"       |
| Y-RTC200 | 2"           |

### 3-piece Union-Malleable Iron / Steel

- Zinc plated

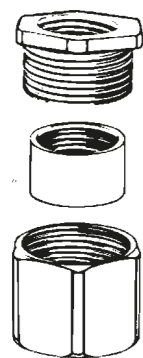

| Cat.No. | Conduit Size |
|---------|--------------|
| TPU-050 | 1/2"         |
| TPU-075 | 3/4"         |
| TPU-100 | 1"           |
| TPU-125 | 1 1/4"       |
| TPU-150 | 1 1/2"       |
| TPU-200 | 2"           |
| TPU-250 | 2 1/2"       |
| TPU-300 | 3"           |
| TPU-350 | 3 1/2"       |
| TPU-400 | 4"           |
| TPU-500 | 5"           |
| TPU-600 | 6"           |

### Plastic Bushing-

- Nylon

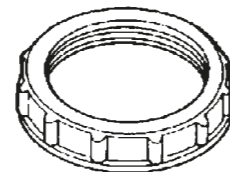

| Cat.No. | Conduit Size |
|---------|--------------|
| IPB-050 | 1/2"         |
| IPB-075 | 3/4"         |
| IPB-100 | 1"           |
| IPB-125 | 1 1/4"       |
| IPB-150 | 1 1/2"       |
| IPB-200 | 2"           |
| IPB-250 | 2 1/2"       |
| IPB-300 | 3"           |
| IPB-350 | 3 1/2"       |
| IPB-400 | 4"           |

## Steel Locknuts

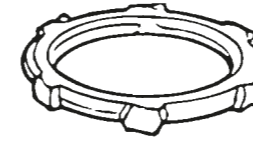

| Cat.No. | Conduit Size |
|---------|--------------|
| LN-050  | 1/2"         |
| LN-075  | 3/4"         |
| LN-100  | 1"           |
| LN-125  | 1 1/4"       |
| LN-150  | 1 1/2"       |
| LN-200  | 2"           |
| LN-250  | 2 1/2"       |
| LN-300  | 3"           |
| LN-350  | 3 1/2"       |
| LN-400  | 4"           |
| LN-500  | 5"           |
| LN-600  | 6"           |

## Zinc Locknuts

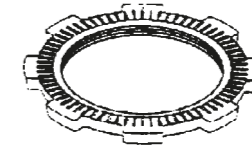

| Cat.No. | Conduit Size |
|---------|--------------|
| ZLN-050 | 1/2"         |
| ZLN-075 | 3/4"         |
| ZLN-100 | 1"           |
| ZLN-125 | 1 1/4"       |
| ZLN-150 | 1 1/2"       |
| ZLN-200 | 2"           |
| ZLN-250 | 2 1/2"       |
| ZLN-300 | 3"           |
| ZLN-350 | 3 1/2"       |
| ZLN-400 | 4"           |

## Conduit Bushing-Die Cast Zinc



| Cat.No.       | Cat.No.  | Conduit Size |
|---------------|----------|--------------|
| Non-Insulated |          |              |
| CB-050        | CB-050I  | 1/2"         |
| CB-075        | CB-075I  | 3/4"         |
| CB-100        | CB-100I  | 1"           |
| CB-125        | CB-125I  | 1 1/4"       |
| CB-150        | CB-150I  | 1 1/2"       |
| CB-200        | CB-200I  | 2"           |
| CB-250        | CB-250I  | 2 1/2"       |
| CB-300        | CB-300I  | 3"           |
| CB-400        | CB-400I  | 4"           |
| Insulated     |          |              |
| CB-050G       | CB-050GI | 1/2"         |
| CB-075G       | CB-075GI | 3/4"         |
| CB-100G       | CB-100GI | 1"           |
| CB-125G       | CB-125GI | 1 1/4"       |
| CB-150G       | CB-150GI | 1 1/2"       |
| CB-200G       | CB-200GI | 2"           |
| CB-250G       | CB-250GI | 2 1/2"       |
| CB-300G       | CB-300GI | 3"           |
| CB-400G       | CB-400GI | 4"           |

## Grounding Bushing-Die Cast Zinc

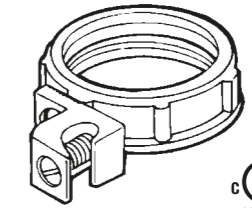

| Cat.No.   | Conduit Size |
|-----------|--------------|
| Insulated |              |
| CB-050G   | 1/2"         |
| CB-075G   | 3/4"         |
| CB-100G   | 1"           |
| CB-125G   | 1 1/4"       |
| CB-150G   | 1 1/2"       |
| CB-200G   | 2"           |
| CB-250G   | 2 1/2"       |
| CB-300G   | 3"           |
| CB-400G   | 4"           |

## Conduit Bushing-Malleable Iron

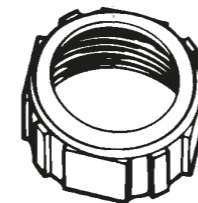

| Cat.No.       | Cat.No.   | Conduit Size |
|---------------|-----------|--------------|
| Non-Insulated |           |              |
| CB-050M       | CB-050MI  | 1/2"         |
| CB-075M       | CB-075MI  | 3/4"         |
| CB-100M       | CB-100MI  | 1"           |
| CB-125M       | CB-125MI  | 1 1/4"       |
| CB-150M       | CB-150MI  | 1 1/2"       |
| CB-200M       | CB-200MI  | 2"           |
| CB-250M       | CB-250MI  | 2 1/2"       |
| CB-300M       | CB-300MI  | 3"           |
| CB-350M       | CB-350MI  | 3 1/2"       |
| CB-400M       | CB-400MI  | 4"           |
| CB-500M       | CB-500MI  | 5"           |
| CB-600M       | CB-600MI  | 6"           |
| Insulated     |           |              |
| CB-050MG      | CB-050MGI | 1/2"         |
| CB-075MG      | CB-075MGI | 3/4"         |
| CB-100MG      | CB-100MGI | 1"           |
| CB-125MG      | CB-125MGI | 1 1/4"       |
| CB-150MG      | CB-150MGI | 1 1/2"       |
| CB-200MG      | CB-200MGI | 2"           |
| CB-250MG      | CB-250MGI | 2 1/2"       |
| CB-300MG      | CB-300MGI | 3"           |
| CB-350MG      | CB-350MGI | 3 1/2"       |
| CB-400MG      | CB-400MGI | 4"           |
| CB-500MG      | CB-500MGI | 5"           |
| CB-600MG      | CB-600MGI | 6"           |

## Grounding Bushing-Malleable Iron

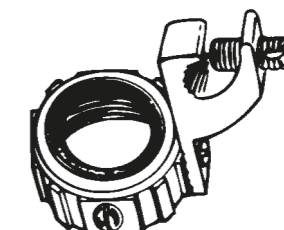

| Cat.No.   | Conduit Size |
|-----------|--------------|
| Insulated |              |
| CB-050MG  | 1/2"         |
| CB-075MG  | 3/4"         |
| CB-100MG  | 1"           |
| CB-125MG  | 1 1/4"       |
| CB-150MG  | 1 1/2"       |
| CB-200MG  | 2"           |
| CB-250MG  | 2 1/2"       |
| CB-300MG  | 3"           |
| CB-350MG  | 3 1/2"       |
| CB-400MG  | 4"           |
| CB-500MG  | 5"           |
| CB-600MG  | 6"           |

## Steel Conduit Fittings

### EMT One Hole Strap

- Electro-galvanized

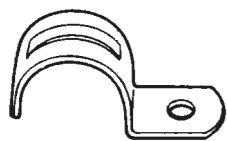

| Cat.No. | Conduit Size |
|---------|--------------|
| OSP-050 | 1/2"         |
| OSP-075 | 3/4"         |
| OSP-100 | 1"           |
| OSP-125 | 1 1/4"       |
| OSP-150 | 1 1/2"       |
| OSP-200 | 2"           |

### EMT Two Hole Strap

- Electro-galvanized

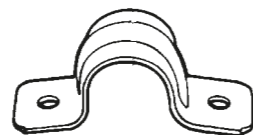

| Cat.No. | Conduit Size |
|---------|--------------|
| TSP-050 | 1/2"         |
| TSP-075 | 3/4"         |
| TSP-100 | 1"           |
| TSP-125 | 1 1/4"       |
| TSP-150 | 1 1/2"       |
| TSP-200 | 2"           |

### Rigid One Hole Strap

- Electro-galvanized



| Cat.No.  | Conduit Size |
|----------|--------------|
| OSP-050R | 1/2"         |
| OSP-075R | 3/4"         |
| OSP-100R | 1"           |
| OSP-125R | 1 1/4"       |
| OSP-150R | 1 1/2"       |
| OSP-200R | 2"           |
| OSP-250R | 2 1/2"       |
| OSP-300R | 3"           |
| OSP-350R | 3 1/2"       |
| OSP-400R | 4"           |

### Rigid Two Hole Strap

- Electro-galvanized

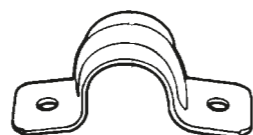

| Cat.No.  | Conduit Size |
|----------|--------------|
| TSP-050R | 1/2"         |
| TSP-075R | 3/4"         |
| TSP-100R | 1"           |
| TSP-125R | 1 1/4"       |
| TSP-150R | 1 1/2"       |
| TSP-200R | 2"           |
| TSP-250R | 2 1/2"       |
| TSP-300R | 3"           |
| TSP-350R | 3 1/2"       |
| TSP-400R | 4"           |

### Strut Clamps

- Electro-galvanized
- Hot dip galvanized
- SS304 / SS316

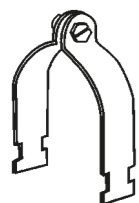

| Cat.No. | Cat.No. | Conduit Size |
|---------|---------|--------------|
|         | Rigid   |              |
|         | EMT     |              |
| SC-050  | SC-050E | 1/2"         |
| SC-075  | SC-075E | 3/4"         |
| SC-100  | SC-100E | 1"           |
| SC-125  | SC-125E | 1 1/4"       |
| SC-150  | SC-150E | 1 1/2"       |
| SC-200  | SC-200E | 2"           |
| SC-250  | -       | 2 1/2"       |
| SC-300  | -       | 3"           |
| SC-350  | -       | 3 1/2"       |
| SC-400  | -       | 4"           |
| SC-500  | -       | 5"           |
| SC-600  | -       | 6"           |
| SC-800  | -       | 8"           |

### Conduit Hanger With Bolt and Nut

- Electro-galvanized



| Cat.No. | Conduit Size |
|---------|--------------|
| CH-050  | 1/2"         |
| CH-075  | 3/4"         |
| CH-100  | 1"           |
| CH-125  | 1 1/4"       |
| CH-150  | 1 1/2"       |
| CH-200  | 2"           |
| CH-250  | 2 1/2"       |
| CH-300  | 3"           |
| CH-350  | 3 1/2"       |
| CH-400  | 4"           |

## Rigid Conduit Fittings

### Rigid Conduit Nipples

- Electro-galvanized

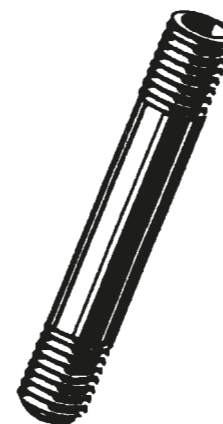

| Cat.No. | Pipe Size | Length |
|---------|-----------|--------|
| 8380    | 1/2"      | Close  |
| 8380112 | 1/2"      | 1 1/2" |
| 83802   | 1/2"      | 2"     |
| 8380212 | 1/2"      | 2 1/2" |
| 83803   | 1/2"      | 3"     |
| 8380312 | 1/2"      | 3 1/2" |
| 83804   | 1/2"      | 4"     |
| 83805   | 1/2"      | 5"     |
| 83806   | 1/2"      | 6"     |
| 83808   | 1/2"      | 8"     |
| 838010  | 1/2"      | 10"    |
| 838012  | 1/2"      | 12"    |
| 8381    | 3/4"      | Close  |
| 83812   | 3/4"      | 2"     |
| 8381212 | 3/4"      | 2 1/2" |
| 83813   | 3/4"      | 3"     |
| 8381312 | 3/4"      | 3 1/2" |
| 83814   | 3/4"      | 4"     |
| 83815   | 3/4"      | 5"     |
| 83816   | 3/4"      | 6"     |
| 83818   | 3/4"      | 8"     |
| 838110  | 3/4"      | 10"    |
| 838112  | 3/4"      | 12"    |
| 8382    | 1"        | Close  |
| 83822   | 1"        | 2"     |
| 8382212 | 1"        | 2 1/2" |
| 83823   | 1"        | 3"     |
| 8382312 | 1"        | 3 1/2" |
| 83824   | 1"        | 4"     |
| 83825   | 1"        | 5"     |
| 83826   | 1"        | 6"     |
| 83828   | 1"        | 8"     |
| 838210  | 1"        | 10"    |
| 838212  | 1"        | 12"    |
| 8383    | 1 1/4"    | Close  |
| 83832   | 1 1/4"    | 2"     |
| 8383212 | 1 1/4"    | 2 1/2" |
| 83833   | 1 1/4"    | 3"     |
| 8383312 | 1 1/4"    | 3 1/2" |
| 83834   | 1 1/4"    | 4"     |
| 83835   | 1 1/4"    | 5"     |
| 83836   | 1 1/4"    | 6"     |
| 83838   | 1 1/4"    | 8"     |
| 838310  | 1 1/4"    | 10"    |
| 838312  | 1 1/4"    | 12"    |

| Cat.No. | Pipe Size | Length |
|---------|-----------|--------|
| 8384    | 1 1/2"    | Close  |
| 83842   | 1 1/2"    | 2"     |
| 8384212 | 1 1/2"    | 2 1/2" |
| 83843   | 1 1/2"    | 3"     |
| 8384312 | 1 1/2"    | 3 1/2" |
| 83844   | 1 1/2"    | 4"     |
| 83845   | 1 1/2"    | 5"     |
| 83846   | 1 1/2"    | 6"     |
| 83848   | 1 1/2"    | 8"     |
| 838410  | 1 1/2"    | 10"    |
| 838412  | 1 1/2"    | 12"    |
| 8385    | 2"        | Close  |
| 8385212 | 2"        | 2 1/2" |
| 83853   | 2"        | 3"     |
| 8385312 | 2"        | 3 1/2" |
| 83854   | 2"        | 4"     |
| 83855   | 2"        | 5"     |
| 83856   | 2"        | 6"     |
| 83858   | 2"        | 8"     |
| 838510  | 2"        | 10"    |
| 838512  | 2"        | 12"    |
| 8386    | 2 1/2"    | Close  |
| 83863   | 2 1/2"    | 3"     |
| 8386312 | 2 1/2"    | 3 1/2" |
| 83864   | 2 1/2"    | 4"     |
| 83865   | 2 1/2"    | 5"     |
| 83866   | 2 1/2"    | 6"     |
| 83868   | 2 1/2"    | 8"     |
| 838610  | 2 1/2"    | 10"    |
| 838612  | 2 1/2"    | 12"    |
| 8387    | 3"        | Close  |
| 83873   | 3"        | 3"     |
| 8387312 | 3"        | 3 1/2" |
| 83874   | 3"        | 4"     |
| 83875   | 3"        | 5"     |
| 83876   | 3"        | 6"     |
| 83878   | 3"        | 8"     |
| 838710  | 3"        | 10"    |
| 838712  | 3"        | 12"    |
| 8388    | 3 1/2"    | Close  |
| 83884   | 3 1/2"    | 4"     |
| 83885   | 3 1/2"    | 5"     |
| 83886   | 3 1/2"    | 6"     |
| 83888   | 3 1/2"    | 8"     |
| 838810  | 3 1/2"    | 10"    |
| 838812  | 3 1/2"    | 12"    |
| 8389    | 4"        | Close  |
| 83894   | 4"        | 4"     |
| 83895   | 4"        | 5"     |
| 83896   | 4"        | 6"     |
| 83898   | 4"        | 8"     |
| 838910  | 4"        | 10"    |
| 838912  | 4"        | 12"    |

### Conduit Nipples-Zinc

- Connect Box to Conduit Coupling

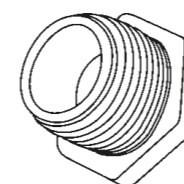

| Cat.No. | Conduit Size |
|---------|--------------|
| MCN-050 | 1/2"         |
| MCN-100 | 3/4"         |
| MCN-100 | 1"           |

## Electrical Accessories

### Rigid Union Male-Steel



| Cat.No. | Conduit Size |
|---------|--------------|
| UNM-050 | 1/2"         |
| UNM-075 | 3/4"         |
| UNM-100 | 1"           |
| UNM-125 | 1 1/4"       |
| UNM-150 | 1 1/2"       |
| UNM-200 | 2"           |
| UNM-250 | 2 1/2"       |
| UNM-300 | 3"           |
| UNM-400 | 4"           |

### Rigid Union Female-Steel



| Cat.No. | Conduit Size |
|---------|--------------|
| UNF-050 | 1/2"         |
| UNF-075 | 3/4"         |
| UNF-100 | 1"           |
| UNF-125 | 1 1/4"       |
| UNF-150 | 1 1/2"       |
| UNF-200 | 2"           |
| UNF-250 | 2 1/2"       |
| UNF-300 | 3"           |
| UNF-400 | 4"           |

### Service Entrance Caps-Aluminum

- Clamp on type



| Cat.No. | Conduit Size |
|---------|--------------|
| CEC-050 | 1/2"         |
| CEC-075 | 3/4"         |
| CEC-100 | 1"           |
| CEC-125 | 1 1/4"       |
| CEC-150 | 1 1/2"       |
| CEC-200 | 2"           |
| CEC-250 | 2 1/2"       |
| CEC-300 | 3"           |
| CEC-350 | 3 1/2"       |
| CEC-400 | 4"           |

### Service Entrance Caps-Aluminum

- Threaded type



| Cat.No. | Conduit Size |
|---------|--------------|
| TEC-050 | 1/2"         |
| TEC-075 | 3/4"         |
| TEC-100 | 1"           |
| TEC-125 | 1 1/4"       |
| TEC-150 | 1 1/2"       |
| TEC-200 | 2"           |
| TEC-250 | 2 1/2"       |
| TEC-300 | 3"           |
| TEC-350 | 3 1/2"       |
| TEC-400 | 4"           |

### Terminal Lug-Single Aluminum



| Cat.No. | Wire Size |
|---------|-----------|
| TA-6S   | 6-14      |
| TA-2    | 2-14      |
| TA-0    | 1/0-14    |
| TA-2/0  | 2/0-14    |
| TA-250  | 250MCM    |
| TA-300  | 300MCM    |
| TA-350  | 350MCM    |
| TA-500  | 500MCM    |
| TA-600  | 600MCM    |

### Terminal Lug-Double Aluminum



| Cat.No. | Wire Size |
|---------|-----------|
| AU-0    | 1/0-14    |
| AU-2/0  | 2/0-14    |
| AU-250  | 250MCM    |
| AU-300  | 300MCM    |
| AU-350  | 350MCM    |
| AU-600  | 600MCM    |
| AU-800  | 800MCM    |
| AU-1000 | 1000MCM   |

### Grounding Terminal-Aluminum



| Cat.No.  | Wire Size |
|----------|-----------|
| GT-4-14  | 4-14#     |
| GT-4-1/0 | 4-1/0#    |

### Knock-out Seals-Steel



| Cat.No. | Size   |
|---------|--------|
| KOS-050 | 1/2"   |
| KOS-075 | 3/4"   |
| KOS-100 | 1"     |
| KOS-125 | 1 1/4" |
| KOS-150 | 1 1/2" |
| KOS-200 | 2"     |

### Earthing Rods-Copper Layer 0.1mm/ 0.25mm

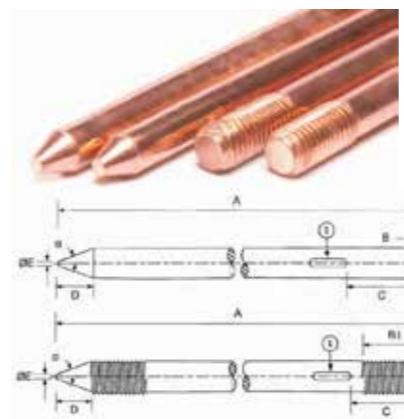

| Dia.(mm)   | A(mm)     | B(mm) | B1(mm) | C(mm)  | D(mm) | ΦE(mm) | a°       |
|------------|-----------|-------|--------|--------|-------|--------|----------|
| 7          | 1000-3000 | 2±2%  | 25±5   | 150±50 | 10-12 | ≤5     | 27.5±2.5 |
| 8          | 1000-3000 | 2±2%  | 25±5   | 150±50 | 10-12 | ≤5     | 27.5±2.5 |
| 10         | 1000-3000 | 2±2%  | 25±5   | 150±50 | 10-12 | ≤5     | 27.5±2.5 |
| 12         | 1000-3000 | 2±2%  | 25±5   | 150±50 | 10-12 | ≤5     | 27.5±2.5 |
| 12.5(1/2") | 1000-3000 | 2±2%  | 25±5   | 150±50 | 10-12 | ≤5     | 27.5±2.5 |
| 14         | 1000-3000 | 2±2%  | 25±5   | 150±50 | 10-12 | ≤5     | 27.5±2.5 |
| 14.2(5/8") | 1000-3000 | 2±2%  | 25±5   | 150±50 | 10-12 | ≤5     | 27.5±2.5 |
| 16         | 1000-3000 | 2±2%  | 25±5   | 150±50 | 10-12 | ≤5     | 27.5±2.5 |
| 17.2(3/4") | 1000-3000 | 2±2%  | 25±5   | 150±50 | 10-12 | ≤5     | 27.5±2.5 |
| 18         | 1000-3000 | 2±2%  | 25±5   | 150±50 | 10-12 | ≤5     | 27.5±2.5 |
| 20         | 1000-3000 | 2±2%  | 25±5   | 150±50 | 10-12 | ≤5     | 27.5±2.5 |
| 22         | 1000-3000 | 2±2%  | 25±5   | 150±50 | 10-12 | ≤5     | 27.5±2.5 |
| 25         | 1000-3000 | 2±2%  | 25±5   | 150±50 | 10-12 | ≤5     | 27.5±2.5 |

### Ground Rod Clamps-Bronze



| Cat.No. | Conduit Size |
|---------|--------------|
| GRC-038 | 3/8"         |
| GRC-050 | 1/2"         |
| GRC-058 | 5/8"         |
| GRC-075 | 3/4"         |
| GRC-100 | 1"           |

### Split Bolt Connector-Solid Bronze



| Cable Size 1 | Cable Size 2 |
|--------------|--------------|
| 16           | 10-16        |
| 25           | 8-12         |
| 35           | 6-10         |
| 50-70        | 4-8          |
| 90-120       | 2(strand)    |
| 150-185      | 1/0          |
| 200-240      | 2/0          |
| -            | 3/0          |
| -            | 4/0          |
| -            | 8-6          |
| -            | 6-3          |
| -            | 3-2          |
| -            | 2-1/0        |

### Floor Outlets with Square Box

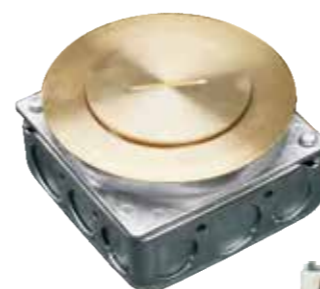

Specification:

| Cat.No. | Description                            |
|---------|--|
| FO-1x2P | with 10A 250V 1x2Pin Receptacle Outlet |
| FO-1x3U | with 3Pin Universal Receptacle Outlet  |
| FO-1x3P | with 15A 125V Receptacle Outlet        |
| FO-2x3P | with 2pcs 15A 125V Receptacle Outlet   |

### Round Meter Socket



### Square Meter Socket







## Rigid / IMC Threaded Type Conduit Body

### LB Style

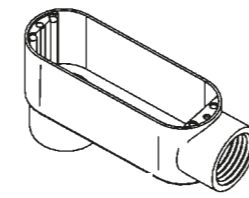

| Cat.No.<br>Aluminum | Conduit<br>Size |
|---------------------|-----------------|
| LB-050              | 1/2"            |
| LB-075              | 3/4"            |
| LB-100              | 1"              |
| LB-125              | 1 1/4"          |
| LB-150              | 1 1/2"          |
| LB-200              | 2"              |
| LB-250              | 2 1/2"          |
| LB-300              | 3"              |
| LB-350              | 3 1/2"          |
| LB-400              | 4"              |

### LL Style

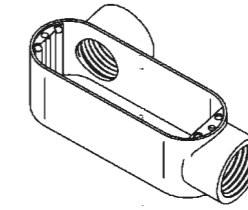

| Cat.No.<br>Aluminum | Conduit<br>Size |
|---------------------|-----------------|
| LL-050              | 1/2"            |
| LL-075              | 3/4"            |
| LL-100              | 1"              |
| LL-125              | 1 1/4"          |
| LL-150              | 1 1/2"          |
| LL-200              | 2"              |
| LL-250              | 2 1/2"          |
| LL-300              | 3"              |
| LL-350              | 3 1/2"          |
| LL-400              | 4"              |

### LR Style

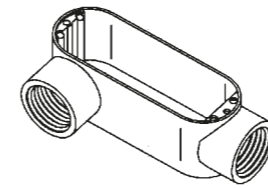

| Cat.No.<br>Aluminum | Conduit<br>Size |
|---------------------|-----------------|
| LR-050              | 1/2"            |
| LR-075              | 3/4"            |
| LR-100              | 1"              |
| LR-125              | 1 1/4"          |
| LR-150              | 1 1/2"          |
| LR-200              | 2"              |
| LR-250              | 2 1/2"          |
| LR-300              | 3"              |
| LR-350              | 3 1/2"          |
| LR-400              | 4"              |

### C Style

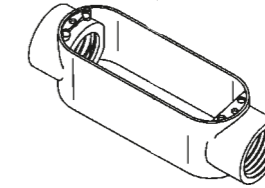

| Cat.No.<br>Aluminum | Conduit<br>Size |
|---------------------|-----------------|
| C-050               | 1/2"            |
| C-075               | 3/4"            |
| C-100               | 1"              |
| C-125               | 1 1/4"          |
| C-150               | 1 1/2"          |
| C-200               | 2"              |
| C-250               | 2 1/2"          |
| C-300               | 3"              |
| C-350               | 3 1/2"          |
| C-400               | 4"              |

### T Style

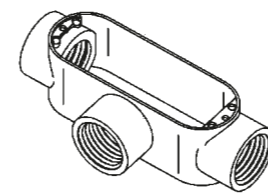

| Cat.No.<br>Aluminum | Conduit<br>Size |
|---------------------|-----------------|
| T-050               | 1/2"            |
| T-075               | 3/4"            |
| T-100               | 1"              |
| T-125               | 1 1/4"          |
| T-150               | 1 1/2"          |
| T-200               | 2"              |
| T-250               | 2 1/2"          |
| T-300               | 3"              |
| T-350               | 3 1/2"          |
| T-400               | 4"              |



### EMT Set Screw Type Conduit Body

#### LBC Style

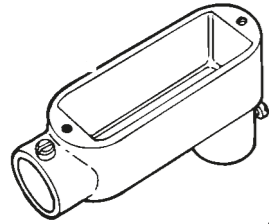

| Cat.No.<br>Aluminum | Conduit<br>Size |
|---------------------|-----------------|
| LBC-050             | 1/2"            |
| LBC-075             | 3/4"            |
| LBC-100             | 1"              |
| LBC-125             | 1 1/4"          |
| LBC-150             | 1 1/2"          |
| LBC-200             | 2"              |
| LBC-250             | 2 1/2"          |
| LBC-300             | 3"              |
| LBC-350             | 3 1/2"          |
| LBC-400             | 4"              |

#### LLC Style

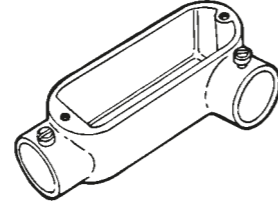

| Cat.No.<br>Aluminum | Conduit<br>Size |
|---------------------|-----------------|
| LLC-050             | 1/2"            |
| LLC-075             | 3/4"            |
| LLC-100             | 1"              |
| LLC-125             | 1 1/4"          |
| LLC-150             | 1 1/2"          |
| LLC-200             | 2"              |
| LLC-250             | 2 1/2"          |
| LLC-300             | 3"              |
| LLC-350             | 3 1/2"          |
| LLC-400             | 4"              |

#### LRC Style

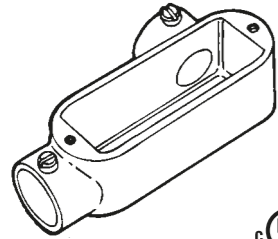

| Cat.No.<br>Aluminum | Conduit<br>Size |
|---------------------|-----------------|
| LRC-050             | 1/2"            |
| LRC-075             | 3/4"            |
| LRC-100             | 1"              |
| LRC-125             | 1 1/4"          |
| LRC-150             | 1 1/2"          |
| LRC-200             | 2"              |
| LRC-250             | 2 1/2"          |
| LRC-300             | 3"              |
| LRC-350             | 3 1/2"          |
| LRC-400             | 4"              |

#### CC Style

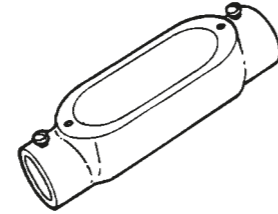

| Cat.No.<br>Aluminum | Conduit<br>Size |
|---------------------|-----------------|
| CC-050              | 1/2"            |
| CC-075              | 3/4"            |
| CC-100              | 1"              |
| CC-125              | 1 1/4"          |
| CC-150              | 1 1/2"          |
| CC-200              | 2"              |
| CC-250              | 2 1/2"          |
| CC-300              | 3"              |
| CC-350              | 3 1/2"          |
| CC-400              | 4"              |

#### TC Style

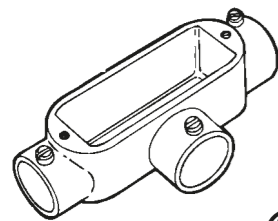

| Cat.No.<br>Aluminum | Conduit<br>Size |
|---------------------|-----------------|
| TC-050              | 1/2"            |
| TC-075              | 3/4"            |
| TC-100              | 1"              |
| TC-125              | 1 1/4"          |
| TC-150              | 1 1/2"          |
| TC-200              | 2"              |
| TC-250              | 2 1/2"          |
| TC-300              | 3"              |
| TC-350              | 3 1/2"          |
| TC-400              | 4"              |

#### Cover & Gasket Stamped Aluminum



| Cat.No.     | Conduit<br>Size |
|-------------|-----------------|
| SAC-050     | 1/2"            |
| SAC-075     | 3/4"            |
| SAC-100     | 1"              |
| SAC-125/150 | 1 1/4"/1 1/2"   |
| SAC-200     | 2"              |
| SAC-250/300 | 2 1/2"/3"       |
| SAC-350/400 | 3 1/2"/4"       |

#### Cover & Gasket Stamped Steel



| Cat.No.    | Conduit<br>Size |
|------------|-----------------|
| CF-050     | 1/2"            |
| CF-075     | 3/4"            |
| CF-100     | 1"              |
| CF-125/150 | 1 1/4"/1 1/2"   |
| CF-200     | 2"              |
| CF-250/300 | 2 1/2"/3"       |
| CF-350/400 | 3 1/2"/4"       |

### EMT / Rigid / IMC Set Screw & Threaded Type Conduit Body

#### LBE Style



| Cat.No.<br>Aluminum | Conduit<br>Size |
|---------------------|-----------------|
| LBE-050             | 1/2"            |
| LBE-075             | 3/4"            |
| LBE-100             | 1"              |
| LBE-125             | 1 1/4"          |
| LBE-150             | 1 1/2"          |
| LBE-200             | 2"              |

#### LLE Style



| Cat.No.<br>Aluminum | Conduit<br>Size |
|---------------------|-----------------|
| LLE-050             | 1/2"            |
| LLE-075             | 3/4"            |
| LLE-100             | 1"              |
| LLE-125             | 1 1/4"          |
| LLE-150             | 1 1/2"          |
| LLE-200             | 2"              |

#### LRE Style



| Cat.No.<br>Aluminum | Conduit<br>Size |
|---------------------|-----------------|
| LRE-050             | 1/2"            |
| LRE-075             | 3/4"            |
| LRE-100             | 1"              |
| LRE-125             | 1 1/4"          |
| LRE-150             | 1 1/2"          |
| LRE-200             | 2"              |

#### CE Style



| Cat.No.<br>Aluminum | Conduit<br>Size |
|---------------------|-----------------|
| CE-050              | 1/2"            |
| CE-075              | 3/4"            |
| CE-100              | 1"              |
| CE-125              | 1 1/4"          |
| CE-150              | 1 1/2"          |
| CE-200              | 2"              |

#### TE Style



| Cat.No.<br>Aluminum | Conduit<br>Size |
|---------------------|-----------------|
| TE-050              | 1/2"            |
| TE-075              | 3/4"            |
| TE-100              | 1"              |
| TE-125              | 1 1/4"          |
| TE-150              | 1 1/2"          |
| TE-200              | 2"              |



## Threaded Type Conduit Body

### LB Style



| Cat.No.        | Conduit Size |
|----------------|--------------|
| Malleable Iron |              |
| MLB-50         | 1/2"         |
| MLB-75         | 3/4"         |
| MLB-100        | 1"           |
| MLB-125        | 1 1/4"       |
| MLB-150        | 1 1/2"       |
| MLB-200        | 2"           |
| MLB-250        | 2 1/2"       |
| MLB-300        | 3"           |
| MLB-350        | 3 1/2"       |
| MLB-400        | 4"           |

### LL Style



| Cat.No.        | Conduit Size |
|----------------|--------------|
| Malleable Iron |              |
| MLL-50         | 1/2"         |
| MLL-75         | 3/4"         |
| MLL-100        | 1"           |
| MLL-125        | 1 1/4"       |
| MLL-150        | 1 1/2"       |
| MLL-200        | 2"           |
| MLL-250        | 2 1/2"       |
| MLL-300        | 3"           |
| MLL-350        | 3 1/2"       |
| MLL-400        | 4"           |

### LR Style



| Cat.No.        | Conduit Size |
|----------------|--------------|
| Malleable Iron |              |
| MLR-50         | 1/2"         |
| MLR-75         | 3/4"         |
| MLR-100        | 1"           |
| MLR-125        | 1 1/4"       |
| MLR-150        | 1 1/2"       |
| MLR-200        | 2"           |
| MLR-250        | 2 1/2"       |
| MLR-300        | 3"           |
| MLR-350        | 3 1/2"       |
| MLR-400        | 4"           |

### C Style



| Cat.No.        | Conduit Size |
|----------------|--------------|
| Malleable Iron |              |
| MC-50          | 1/2"         |
| MC-75          | 3/4"         |
| MC-100         | 1"           |
| MC-125         | 1 1/4"       |
| MC-150         | 1 1/2"       |
| MC-200         | 2"           |
| MC-250         | 2 1/2"       |
| MC-300         | 3"           |
| MC-350         | 3 1/2"       |
| MC-400         | 4"           |

### T Style



| Cat.No.        | Conduit Size |
|----------------|--------------|
| Malleable Iron |              |
| MT-50          | 1/2"         |
| MT-75          | 3/4"         |
| MT-100         | 1"           |
| MT-125         | 1 1/4"       |
| MT-150         | 1 1/2"       |
| MT-200         | 2"           |
| MT-250         | 2 1/2"       |
| MT-300         | 3"           |
| MT-350         | 3 1/2"       |
| MT-400         | 4"           |

### TB Style



| Cat.No.        | Conduit Size |
|----------------|--------------|
| Malleable Iron |              |
| MTB-50         | 1/2"         |
| MTB-75         | 3/4"         |
| MTB-100        | 1"           |
| MTB-125        | 1 1/4"       |
| MTB-150        | 1 1/2"       |
| MTB-200        | 2"           |

### X Style



| Cat.No.        | Conduit Size |
|----------------|--------------|
| Malleable Iron |              |
| MX-50          | 1/2"         |
| MX-75          | 3/4"         |
| MX-100         | 1"           |
| MX-125         | 1 1/4"       |
| MX-150         | 1 1/2"       |
| MX-200         | 2"           |

## Aluminum Weatherproof Boxes

### 4x2" Single Gang

|               | Cat.No.  | Hub Size | Deep   | Outlets  |
|---------------|----------|----------|--------|----------|
| Three Outlets | 1G50-3   | 1/2"     | 2"     | Top 1    |
|               | 1G75-3   | 3/4"     | 2"     | Bottom 1 |
|               | 1G100-3  | 1"       | 2"     | Back 1   |
|               | 1DG50-3  | 1/2"     | 2 5/8" | Total 3  |
|               | 1DG75-3  | 3/4"     | 2 5/8" |          |
|               | 1DG100-3 | 1"       | 2 5/8" |          |

|              | Cat.No. | Hub Size | Deep   | Outlets  |
|--------------|---------|----------|--------|----------|
| Four Outlets | 1G50-4  | 1/2"     | 2"     | Top 2    |
|              | 1G75-4  | 3/4"     | 2"     | Bottom 1 |
|              | 1DG50-4 | 1/2"     | 2 5/8" | Back 1   |
|              | 1DG75-4 | 3/4"     | 2 5/8" | Total 4  |

|              | Cat.No. | Hub Size | Deep | Outlets  |
|--------------|---------|----------|------|----------|
| Five Outlets | 1G50-5  | 1/2"     | 2"   | Top 2    |
|              | 1G75-5  | 3/4"     | 2"   | Bottom 2 |
|              |         |          |      | Back 1   |
|              |         |          |      | Total 5  |

|                      | Cat.No.   | Hub Size | Deep   | Outlets  |
|----------------------|-----------|----------|--------|----------|
| Five Outlets(2 side) | 1G50-5X   | 1/2"     | 2"     | Top 1    |
|                      | 1G75-5X   | 3/4"     | 2"     | Bottom 1 |
|                      | 1DG50-5X  | 1/2"     | 2 5/8" | Side 1   |
|                      | 1DG75-5X  | 3/4"     | 2 5/8" | Side 1   |
|                      | 1DG100-5X | 1"       | 2 5/8" | Back 1   |
|                      |           |          |        | Total 5  |

### Three Gang

|            | Cat.No. | Hub Size | Deep   | Outlets  |
|------------|---------|----------|--------|----------|
| Three Gang | 3G50-7  | 1/2"     | 2 5/8" | Top 3    |
|            | 3G75-7  | 3/4"     | 2 5/8" | Bottom 3 |
|            | 3G100-7 | 1"       | 2 5/8" | Back 1   |
|            |         |          |        | Total 7  |

### 4" Round Boxes

|                | Cat.No. | Hub Size | Deep   | Outlets  |
|----------------|---------|----------|--------|----------|
| 4" Round Boxes | RB50-5  | 1/2"     | 1 1/8" | Bottom 1 |
|                | RB75-5  | 3/4"     | 1 1/8" | Side 1   |
|                |         |          |        | Side 1   |
|                |         |          |        | Side 1   |
|                |         |          |        | Side 1   |
|                |         |          |        | Total 5  |

### 4x4" Two Gang

|               | Cat.No. | Hub Size | Deep    | Outlets  |
|---------------|---------|----------|---------|----------|
| Three Outlets | 2G50-3  | 1/2"     | 2 3/16" | Top 1    |
|               | 2G75-3  | 3/4"     | 2 3/16" | Bottom 1 |
|               | 2G100-3 | 1"       | 2 3/16" | Back 1   |
|               |         |          |         | Total 3  |

|              | Cat.No. | Hub Size | Deep    | Outlets  |
|--------------|---------|----------|---------|----------|
| Four Outlets | 2G50-4  | 1/2"     | 2 3/16" | Top 2    |
|              | 2G75-4  | 3/4"     | 2 3/16" | Bottom 1 |
|              | 2G100-4 | 1"       | 2 3/16" | Back 1   |
|              |         |          |         | Total 4  |

|              | Cat.No.  | Hub Size | Deep    | Outlets  |
|--------------|----------|----------|---------|----------|
| Five Outlets | 2G50-5   | 1/2"     | 2 3/16" | Top 2    |
|              | 2G75-5   | 3/4"     | 2 3/16" | Bottom 2 |
|              | 2DG50-5  | 1/2"     | 2 5/8"  | Back 1   |
|              | 2DG75-5  | 3/4"     | 2 5/8"  | Total 5  |
|              | 2DG100-5 | 1"       | 2 5/8"  |          |

|                      | Cat.No.  | Hub Size | Deep    | Outlets  |
|----------------------|----------|----------|---------|----------|
| Five Outlets(2 side) | 2G50-5X  | 1/2"     | 2 3/16" | Top 1    |
|                      | 2G75-5X  | 3/4"     | 2 3/16" | Bottom 1 |
|                      | 2G100-5X | 1"       | 2 3/16" | Side 1   |
|                      |          |          |         | Side 1   |
|                      |          |          |         | Back 1   |
|                      |          |          |         | Total 5  |

|               | Cat.No. | Hub Size | Deep    | Outlets  |
|---------------|---------|----------|---------|----------|
| Seven Outlets | 2G50-7  | 1/2"     | 2 3/16" | Top 3    |
|               | 2G75-7  | 3/4"     | 2 3/16" | Bottom 3 |
|               |         |          |         | Back 1   |
|               |         |          |         | Total 7  |

|                       | Cat.No.   | Hub Size | Deep    | Outlets  |
|-----------------------|-----------|----------|---------|----------|
| Seven Outlets(2 side) | 2G50-7X   | 1/2"     | 2 3/16" | Top 2    |
|                       | 2G75-7X   | 3/4"     | 2 3/16" | Bottom 2 |
|                       | 2DG50-7X  | 1/2"     | 2 5/8"  | Side 1   |
|                       | 2DG75-7X  | 3/4"     | 2 5/8"  | Side 1   |
|                       | 2DG100-7X | 1"       | 2 5/8"  | Back 1   |
|                       |           |          |         | Total 7  |

|              | Cat.No. | Hub Size | Deep    | Outlets  |
|--------------|---------|----------|---------|----------|
| Nine Outlets | 2G50-9  | 1/2"     | 2 3/16" | Top 3    |
|              | 2G75-9  | 3/4"     | 2 3/16" | Bottom 3 |
|              |         |          |         | Side 1   |
|              |         |          |         | Side 1   |
|              |         |          |         | Back 1   |
|              |         |          |         | Total 9  |

## Weatherproof Boxes and Covers

### Extensions-Single Gang

| Cat.No. | Hub Size | Deep   | Outlets |
|---------|----------|--------|---------|
| EXR-1   | N/A      | 1 3/8" | 0       |
| EXB50-4 | 1/2"     | 1 3/8" | 4       |
| EXB75-4 | 3/4"     | 1 3/8" | 4       |
| EXB50-6 | 1/2"     | 1 3/8" | 6       |
| EXB75-6 | 3/4"     | 1 3/8" | 6       |

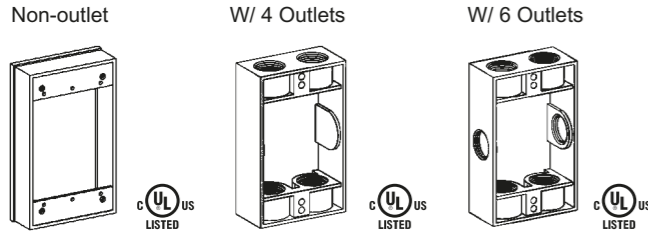

| Cat.No. | Hub Size | Deep   | Outlets |
|---------|----------|--------|---------|
| EXF50-2 | 1/2"     | 1 3/8" | 2       |
| EXF50-4 | 1/2"     | 1 3/8" | 4       |
| EXF75-4 | 3/4"     | 1 3/8" | 4       |
| EXF50-6 | 1/2"     | 1 3/8" | 6       |
| EXF75-6 | 3/4"     | 1 3/8" | 6       |

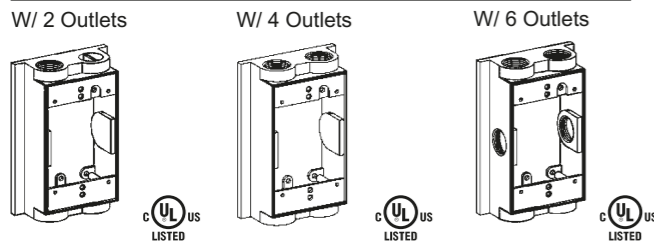

### Blank Covers

|             | Cat.No. | Description         |
|-------------|---------|---------------------|
| Round       | RBC-4   | 4" Round Cover      |
| Single Gang | 1BC     | 1 Gang Device Mount |
| Two Gang    | 2BC     | 2 Gang Device Mount |
| Three Gang  | 3BC     | 3 Gang Device Mount |

### Extensions-Two Gang

| Cat.No.  | Hub Size | Deep   | Outlets |
|----------|----------|--------|---------|
| EXR-2    | -        | 1 3/8" | 0       |
| 2EXB50-6 | 1/2"     | 1 3/8" | 6       |
| 2EXB75-6 | 3/4"     | 1 3/8" | 6       |
| 2EXB50-8 | 1/2"     | 1 3/8" | 8       |
| 2EXB75-8 | 3/4"     | 1 3/8" | 8       |

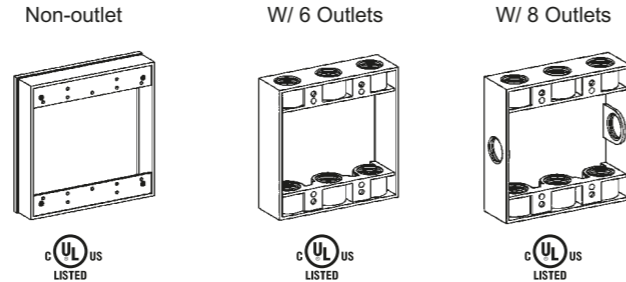

### Extensions-Round

| Cat.No. | Hub Size | Deep   | Outlets |
|---------|----------|--------|---------|
| EXR50-4 | 1/2"     | 1 3/8" | 4       |
| EXR75-4 | 3/4"     | 1 3/8" | 4       |

### Closure Plugs

| Cat.No. | Hub Size |
|---------|----------|
| PL-050  | 1/2"     |
| PL-075  | 3/4"     |
| PL-100  | 1"       |

### Lampholder-Aluminum

| Cat.No.  | Description                                |
|----------|--|
| LH-150-5 | Inside gasket and ground screw 150W PAR 38 |

### Lampholder Assemblies-Aluminum

| Cat.No. | Description                                  |
|---------|--|
| LC23N   | 120V 150W PAR 38 Lampholder with Round Cover |

## Weatherproof Box Covers

### 4" Round Lamp Holder Covers Aluminum



### Jumbo Covers-Aluminum



### Single Lamp Holder Covers Aluminum

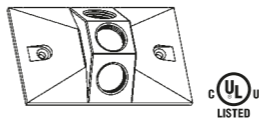

### Single Gang Device Covers

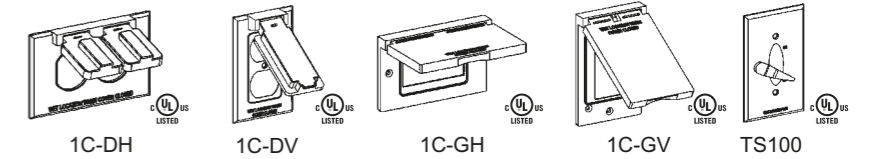

| Cat.No. | Description                         |
|---------|-------------------------------------|
| 1C-DH   | Duplex Receptacle Cover, Horizontal |
| 1C-DV   | Duplex Receptacle Cover, Vertical   |
| 1C-GH   | GFCI Receptacle Cover, Horizontal   |
| 1C-GV   | GFCI Receptacle Cover, Vertical     |
| TS100   | One Gang Cover                      |

### Two Gang Device Covers

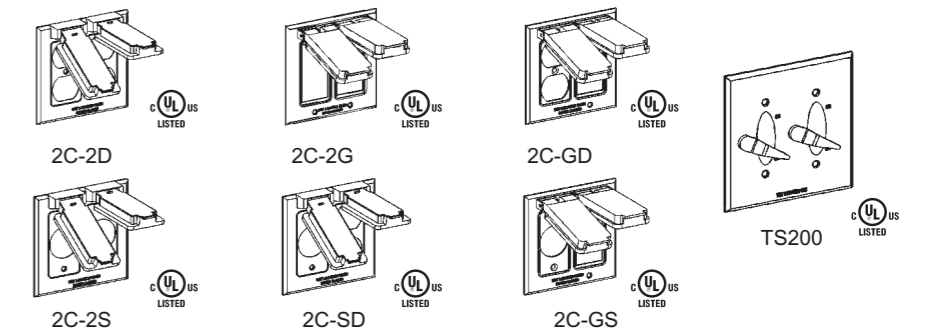

| Cat.No. | Description  |
|---------|--|
| 2C-2D   | Two Duplex Receptacle Cover, Horizontal                            |
| 2C-2G   | Two GFCI Receptacle Cover, Vertical                                |
| 2C-GD   | One Duplex and one GFCI Receptacle Cover                           |
| 2C-2S   | Two single Receptacle Cover-1.41" Dia. opening                     |
| 2C-SD   | One single and One Duplex Receptacle Cover-1.41" Dia. opening      |
| 2C-GS   | Single Receptacle and one GFCI Receptacle Cover-1.41" Dia. opening |
| TS200   | Double Switch Cover  |



## Square Boxes and Covers

### 4" Square Boxes, Drawn Type



| Cat.No.  | Knockouts      |                |
|--|----------------|----------------|
|  | Side           | Bottom         |
| <b>1/2" Deep-with Conduit KO's</b><br>Thickness: 0.8mm 1.0mm 1.2mm 1.4mm 1.5mm 1.6mm   |                |                |
| 52151-1/2  | 12x1/2"        | 5x1/2"         |
| 52151-3/4  | 8x3/4"         | 3x1/2", 2x3/4" |
| 52151-1/2&3/4  | 8x1/2", 4x3/4" | 3x1/2", 2x3/4" |
| <b>1 1/8" Deep-with Conduit KO's</b><br>Thickness: 0.8mm 1.0mm 1.2mm 1.4mm 1.5mm 1.6mm |                |                |
| 52161-1/2  | 12x1/2"        | 5x1/2"         |
| 52161-3/4  | 8x3/4"         | 3x1/2", 2x3/4" |
| 52161-1/2&3/4  | 8x1/2", 4x3/4" | 3x1/2", 2x3/4" |
| 52161-1  | 8x1"           | 3x1/2", 2x3/4" |
| 52161-3/4&1  | 4x3/4", 4x1"   | 3x1/2", 2x3/4" |
| <b>2 1/8" Deep-with Conduit KO's</b><br>Thickness: 1.0mm 1.2mm 1.4mm 1.5mm 1.6mm       |                |                |
| 52171-1/2  | 12x1/2"        | 5x1/2"         |
| 52171-3/4  | 8x3/4"         | 3x1/2", 2x3/4" |
| 52171-1/2&3/4  | 8x1/2", 4x3/4" | 3x1/2", 2x3/4" |
| 52171-1  | 8x1"           | 3x1/2", 2x3/4" |
| 52171-3/4&1  | 4x3/4", 4x1"   | 3x1/2", 2x3/4" |

Note: Concentric KO.type & Grounding type also available

### 4" Square Device Covers

For Single Device, Steel

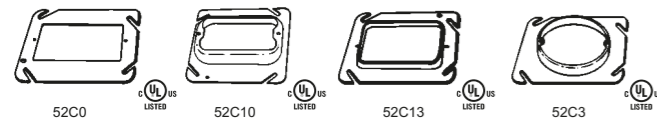

| Cat.No.                            | Raised | Description       |
|------------------------------------|--------|-------------------|
| Thickness: 1.0mm 1.2mm 1.5mm 1.6mm |        |                   |
| 52C0                               | 0      | Flat              |
| 52C10                              | 1/4"   | -                 |
| 52C62                              | 1/4"   | Keyed for Plaster |
| 52C13                              | 1/2"   | -                 |
| 52C3                               | 1/2"   | W/ Mud Ring       |

### 4" Square Extension Rings, Drawn Type



| Cat.No.  | Knockouts      |  |
|--|----------------|--|
|  | EA.Side        |  |
| <b>1/2" Deep-with Conduit KO's</b><br>Thickness: 0.8mm 1.0mm 1.2mm 1.4mm 1.5mm |                |  |
| 53151-1/2  | 12x1/2"        |  |
| 53151-3/4  | 8x1/2"         |  |
| 53151-1/2&3/4  | 8x1/2", 4x3/4" |  |
| <b>2 1/8" Deep-with Conduit KO's</b><br>Thickness: 1.0mm 1.2mm 1.4mm 1.5mm     |                |  |
| 53171-1/2  | 12x1/2"        |  |
| 53171-3/4  | 8x3/4"         |  |
| 53171-1/2&3/4  | 8x1/2", 4x3/4" |  |
| 53171-1  | 8x1"           |  |
| 53171-3/4&1  | 4x3/4", 4x1"   |  |

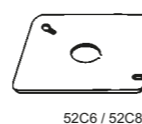
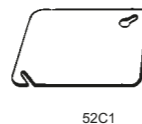

### 4" Square Box Covers

Thickness: 0.8mm 1.0mm 1.2mm 1.5mm 1.6mm

| Cat.No. | Description         |
|---------|---------------------|
| 52C1    | Flat, blank         |
| 52C6    | Flat, with 1/2" KO. |
| 52C8    | Flat, with 3/4" KO. |

### 4" Square Device Covers

For Two Devices, Steel

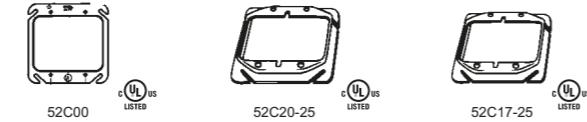

| Cat.No.                            | Raised | Description |
|------------------------------------|--------|-------------|
| Thickness: 1.0mm 1.2mm 1.5mm 1.6mm |        |             |
| 52C00                              | 0      | Flat        |
| 52C20-25                           | 1/4"   | -           |
| 52C17-25                           | 1/2"   | -           |

## Rectangular Boxes and Covers

### 4x2" Rectangular Boxes, Drawn Type

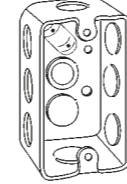

| Cat.No.  | Knockouts      |                |
|--|----------------|----------------|
|  | Side           | Bottom         |
| <b>1/2" Deep-with Conduit KO's</b><br>Thickness: 0.8mm 1.0mm 1.2mm 1.4mm 1.5mm         |                |                |
| 58351-1/2  | 8x1/2"         | 3x1/2"         |
| 58351-3/4  | 6x3/4"         | 2x3/4"         |
| 58351-1/2&3/4  | 6x1/2", 2x3/4" | 2x1/2", 1x3/4" |
| <b>1 1/8" Deep-with Conduit KO's</b><br>Thickness: 0.8mm 1.0mm 1.2mm 1.4mm 1.5mm 1.6mm |                |                |
| 58361-1/2  | 8x1/2"         | 3x1/2"         |
| 58361-3/4  | 6x3/4"         | 2x3/4"         |
| 58361-1/2&3/4  | 4x1/2", 4x3/4" | 2x1/2", 1x3/4" |
| <b>2 1/8" Deep-with Conduit KO's</b><br>Thickness: 1.0mm 1.2mm 1.4mm 1.5mm 1.6mm       |                |                |
| 58371-1/2  | 8x1/2"         | 3x1/2"         |
| 58371-3/4  | 6x3/4"         | 2x3/4"         |
| 58371-1/2&3/4  | 4x1/2", 4x3/4" | 2x1/2", 1x3/4" |
| 58371-1  | 6x1"           | 2x1/2", 1x3/4" |

Note: Concentric KO.type & Grounding type also available

### 4x2" Rectangular Box Covers

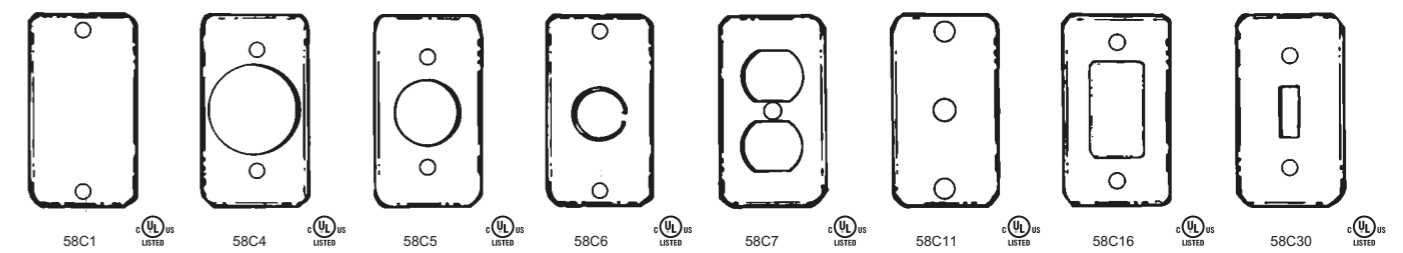

| Cat.No.                            | Hole Size | Description                                   |
|------------------------------------|-----------|---|
| Thickness: 0.8mm 1.0mm 1.2mm 1.5mm |           |   |
| 58C1                               |           | Blank   |
| 58C4                               | 1 1/32"   | For 4-wire twist-lock single flush receptacle |
| 58C5                               | 1 1/32"   | For single receptacle                         |
| 58C6                               |           | With 1/2" KO.                                 |
| 58C7                               |           | For duplex flush receptacle                   |
| 58C11                              |           | With 1 5/32" bushed hole                      |
| 58C16                              |           | For single GFCI receptacle                    |
| 58C30                              |           | For one toggle switch                         |

### 4x2" Rectangular Box Extension Rings

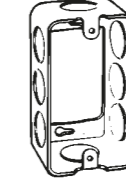

| Cat.No.  | Knockouts      |  |
|--|----------------|--|
|  | EA.Side        |  |
| <b>1/2" Deep-with Conduit KO's</b><br>Thickness: 0.8mm 1.0mm 1.2mm 1.5mm         |                |  |
| 59351-1/2  | 8x1/2"         |  |
| <b>1 1/8" Deep-with Conduit KO's</b><br>Thickness: 0.8mm 1.0mm 1.2mm 1.4mm 1.5mm |                |  |
| 59361-1/2  | 8x1/2"         |  |
| 59361-3/4  | 6x3/4"         |  |
| 59361-1/2&3/4  | 4x1/2", 4x3/4" |  |
| <b>2 1/8" Deep-with Conduit KO's</b><br>Thickness: 1.0mm 1.2mm 1.4mm 1.5mm       |                |  |
| 59371-1/2  | 8x1/2"         |  |
| 59371-3/4  | 6x3/4"         |  |
| 59371-1/2&3/4  | 4x1/2", 4x3/4" |  |
| 59371-1  | 6x1"           |  |



## Octagonal Boxes and Covers

### 4" Octagonal Boxes, Drawn Type

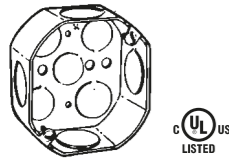

| Cat.No.   | Knockouts      |                |
|---|----------------|----------------|
|   | Side           | Bottom         |
| 1 1/2" Deep-with Conduit KO's<br>Thickness: 0.8mm 1.0mm 1.2mm 1.4mm 1.5mm 1.6mm |                |                |
| 54151-1/2   | 4x1/2"         | 5x1/2"         |
| 54151-3/4   | 4x3/4"         | 3x1/2", 2x3/4" |
| 54151-1/2&3/4   | 2x1/2", 2x3/4" | 3x1/2", 2x3/4" |
| 1 7/8" Deep-with Conduit KO's<br>Thickness: 0.8mm 1.0mm 1.2mm 1.4mm 1.5mm 1.6mm |                |                |
| 54161-1/2   | 4x1/2"         | 5x1/2"         |
| 54161-3/4   | 4x3/4"         | 3x1/2", 2x3/4" |
| 54161-1/2&3/4   | 2x1/2", 2x3/4" | 3x1/2", 2x3/4" |
| 2 1/8" Deep-with Conduit KO's<br>Thickness: 1.0mm 1.2mm 1.4mm 1.5mm 1.6mm       |                |                |
| 54171-1/2   | 4x1/2"         | 5x1/2"         |
| 54171-3/4   | 4x3/4"         | 3x1/2", 2x3/4" |
| 54171-1/2&3/4   | 2x1/2", 2x3/4" | 3x1/2", 2x3/4" |
| 54171-1   | 4x1"           | 3x1/2", 2x3/4" |
| 54171-3/4&1   | 2x3/4", 2x1"   | 3x1/2", 2x3/4" |

Note: Concentric KO.type & Grounding type also available

### 4" Octagonal Box Extension Rings, Drawn Type

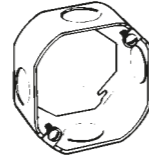

| Cat.No.   | Knockouts      |  |
|---|----------------|--|
|   | EA.Side        |  |
| 1 1/2" Deep-with Conduit KO's<br>Thickness: 0.8mm 1.0mm 1.2mm 1.5mm 1.6mm |                |  |
| 55151-1/2   | 4x1/2"         |  |
| 55151-3/4   | 4x3/4"         |  |
| 55151-1/2&3/4   | 2x1/2", 2x3/4" |  |

### 4" Octagonal Side Boxes, Drawn Type

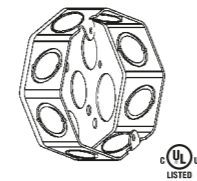

| Cat.No.   | Knockouts              |                |
|---|------------------------|----------------|
|   | EA.Side                | Bottom         |
| 1 3/4" Deep-with Conduit KO's<br>Thickness: 0.8mm 1.0mm 1.2mm 1.4mm 1.5mm 1.6mm |                        |                |
| 54151C-1/2&3/4  | 6x1/2"&3/4" Concentric | 2x1/2", 1x3/4" |

### 4" Octagonal Box Covers

Thickness: 0.8mm 1.0mm 1.2mm 1.5mm 1.6mm

| Cat.No. | Description         |
|---------|---------------------|
| 54C1    | Flat, blank         |
| 54C6    | Flat, with 1/2" KO. |
| 54C8    | Flat, with 3/4" KO. |

### 4" Octagonal Box Round Covers

Thickness: 0.8mm 1.0mm 1.2mm 1.5mm 1.6mm

| Cat.No. | Description         |
|---------|---------------------|
| 54C1R   | Flat, blank         |
| 54C6R   | Flat, with 1/2" KO. |
| 54C8R   | Flat, with 3/4" KO. |
| 54C3    | W/ Mud Ring         |

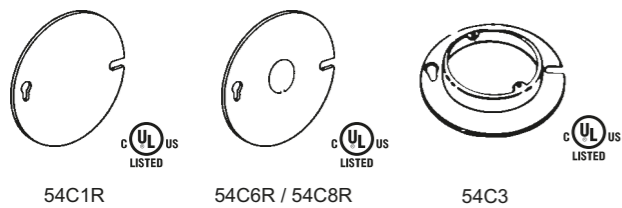
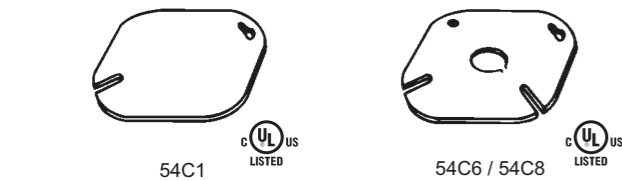

## Square Boxes and Covers

### 4" Square Boxes, Weld Type

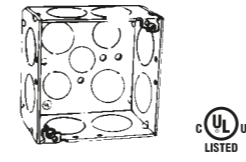

| Cat.No.   | Knockouts      |                |
|---|----------------|----------------|
|   | EA.Side        | Bottom         |
| 2 1/8" Deep-with Conduit KO's<br>Thickness: 1.2mm 1.5mm 1.6mm |                |                |
| 52171W-1/2  | 12x1/2"        | 3x1/2", 2x3/4" |
| 52171W-3/4  | 8x3/4"         | 3x1/2", 2x3/4" |
| 52171W-1/2&3/4  | 8x1/2", 4x3/4" | 3x1/2", 2x3/4" |
| 52171W-1  | 8x1"           | 3x1/2", 2x3/4" |
| 52171W-3/4&1  | 4x3/4", 4x1"   | 3x1/2", 2x3/4" |

Note: Concentric KO.type & Grounding type also available

### 4-11/16" Square Box Cover

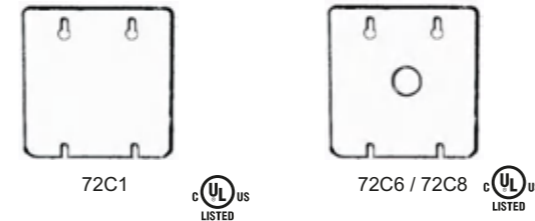

Thickness: 1.0mm 1.2mm 1.5mm 1.6mm

| Cat.No. | Description         |
|---------|---------------------|
| 72C1    | Flat, blank         |
| 72C6    | Flat, with 1/2" KO. |
| 72C8    | Flat, with 3/4" KO. |

### 4-11/16" Square Boxes, Weld Type

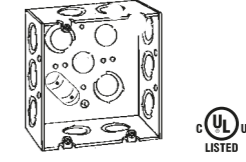

| Cat.No.   | Knockouts      |                |
|---|----------------|----------------|
|   | EA.Side        | Bottom         |
| 2 1/8" Deep-with Conduit KO's<br>Thickness: 1.2mm 1.5mm 1.6mm |                |                |
| 72171W-3/4  | 8x3/4"         | 5x1/2"         |
| 72171W-1/2&3/4  | 8x1/2", 4x3/4" | 3x1/2", 2x3/4" |
| 72171W-1  | 8x1"           | 3x1/2", 2x3/4" |
| 72171W-3/4&1  | 4x3/4", 4x1"   | 3x1/2", 2x3/4" |
| 72171W-1/4  | 4x1-1/4"       | 3x1/2", 2x3/4" |

Note: Concentric KO.type & Grounding type also available

### 4-11/16" Square Boxes, Drawn Type



| Cat.No.   | Knockouts      |                |
|---|----------------|----------------|
|   | EA.Side        | Bottom         |
| 2 1/8" Deep-with Conduit KO's<br>Thickness: 1.2mm 1.5mm 1.6mm |                |                |
| 72171-1/2   | 12x1/2"        | 5x1/2"         |
| 72171-3/4   | 8x3/4"         | 3x1/2", 2x3/4" |
| 72171-1/2&3/4   | 8x1/2", 4x3/4" | 3x1/2", 2x3/4" |
| 72171-1   | 8x1"           | 3x1/2", 2x3/4" |
| 72171-3/4&1   | 4x3/4", 4x1"   | 3x1/2", 2x3/4" |
| 72171-1/4   | 4x1-1/4"       | 3x1/2", 2x3/4" |

Note: Concentric KO.type & Grounding type also available

### Multi-gang Box and Covers

| Type  | Knockouts               |                |
|---|-------------------------|----------------|
|   | EA.Side                 | Bottom         |
| 1 7/8" Deep-with Conduit KO's<br>Thickness: 1.6mm |                         |                |
| 2 gang  | 12x1/2"&3/4" Concentric | 4x1/2", 2x3/4" |
| 3 gang  | 14x1/2"&3/4" Concentric | 6x1/2", 4x3/4" |
| 4 gang  | 16x1/2"&3/4" Concentric | 6x1/2", 4x3/4" |
| 5 gang  | 18x1/2"&3/4" Concentric | 6x1/2", 4x3/4" |

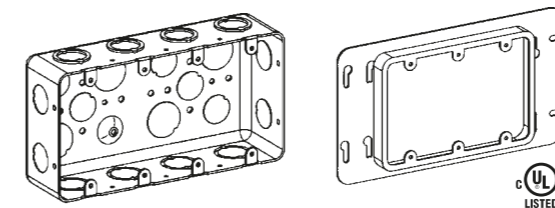

## Electrial Conduit Box

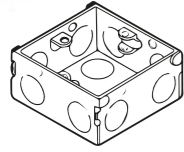

1 Gang Metal Junction Box

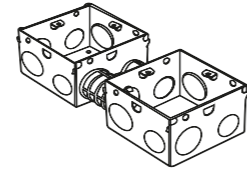

2 Gang BS GI Box

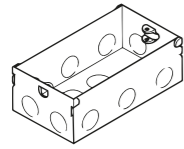

Double Metal Junction Box

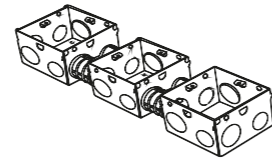

3 Gang BS GI Box

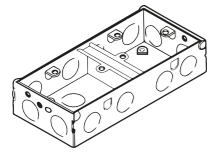

1+1 Metal Junction Box

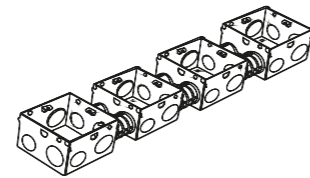

4 Gang BS GI Box



1+1+1 Metal Junction Box

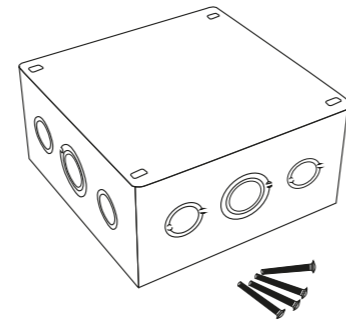

1+1+1+1 Metal Junction Box



100x50mm Magic Box

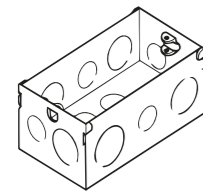

### 1 Gang Switch Box Cover



| Cat.# | Description |
|-------|-------------|
| 55C20 | 20mm K.O.   |
| 55C25 | 25mm K.O.   |
| 55C6  | 1/2" K.O.   |
| 55C8  | 3/4" K.O.   |

## Adaptable GI Box & Cover

|            |             |
|------------|-------------|
| 100x100x55 | 100x100x100 |
| 150x150x50 | 150x150x100 |
| 200x200x50 | 200x200x100 |
| 250x250x50 | 250x250x100 |
| 300x300x50 | 300x300x100 |
| 400x400x50 | 400x400x100 |
| 150x150x75 | 150x150x150 |
| 200x200x75 | 200x200x150 |
| 250x250x75 | 250x250x150 |
| 300x300x75 | 300x300x150 |
| 400x400x75 | 400x400x150 |



**Galvanized Flexible Conduit-Economic**  
To South American and Middle East Market



| Trade Size | Inside Dia. (mm) |                   | Coil Length (m) |
|------------|------------------|-------------------|-----------------|
|            | Inside Dia. (mm) | Outside Dia. (mm) |                 |
| 3/8"       | 13               | 15.5              | 100/50/30       |
| 1/2"       | 19               | 21.5              | 100/50/30       |
| 3/4"       | 22               | 26                | 100/50/30       |
| 1"         | 28               | 31                | 100/50/30       |
| 1 1/4"     | 35               | 39                | 50/25/20        |
| 1 1/2"     | 42               | 46                | 50/25/15        |
| 2"         | 54               | 60                | 50/15/10        |
| 2 1/2"     | 66               | 74                | 20/15/10        |
| 3"         | 78               | 88                | 20/15/10        |
| 4"         | 100              | 113               | 20/15/10        |

Other length of per coil also available

**Greenfield Flexible Conduit-Heavy Duty**  
To American Market



| Trade Size | Inside Dia. (mm) |                   | Coil Length (m) |
|------------|------------------|-------------------|-----------------|
|            | Inside Dia. (mm) | Outside Dia. (mm) |                 |
| 3/8"       | 10.0             | 14.8              | 50/30           |
| 1/2"       | 16.4             | 22.5              | 50/30           |
| 3/4"       | 20.5             | 26.4              | 50/30           |
| 1"         | 26.4             | 32.5              | 50/30           |
| 1 1/4"     | 32.5             | 40.2              | 25/15           |
| 1 1/2"     | 38.9             | 47.0              | 25/15           |
| 2"         | 51.9             | 61.0              | 15/7.5          |
| 2 1/2"     | 63.0             | 74.0              | 15/7.5          |
| 3"         | 75.0             | 88.0              | 15/7.5          |
| 4"         | 100.0            | 114.0             | 15/7.5          |

Other length of per coil also available

**Squeeze Connector Straight-**  
Die Cast Zinc



| Cat.No.       | Conduit Size |
|---------------|--------------|
| Non-insulated |              |
| SSC-038       | 3/8"         |
| SSC-050       | 1/2"         |
| SSC-075       | 3/4"         |
| SSC-100       | 1"           |
| SSC-125       | 1 1/4"       |
| SSC-150       | 1 1/2"       |
| SSC-200       | 2"           |
| SSC-250       | 2 1/2"       |
| SSC-300       | 3"           |
| SSC-400       | 4"           |

**90° Squeeze Connector-**  
Die Cast Zinc



| Cat.No.       | Conduit Size |
|---------------|--------------|
| Non-insulated |              |
| ASC-038       | 3/8"         |
| ASC-050       | 1/2"         |
| ASC-075       | 3/4"         |
| ASC-100       | 1"           |
| ASC-125       | 1 1/4"       |
| ASC-150       | 1 1/2"       |
| ASC-200       | 2"           |
| ASC-250       | 2 1/2"       |
| ASC-300       | 3"           |
| ASC-400       | 4"           |

**Liquid Tight Conduit with Filler of Cord**



| Trade Size | Inside Dia.(mm) |       | Outside Dia.(mm) |       | Coil Length (m) | Color      |
|------------|-----------------|-------|------------------|-------|-----------------|------------|
|            | Min.            | Max.  | Min.             | Max.  |                 |            |
| 3/8"       | 12.2            | 12.8  | 17.5             | 18.0  | 100/50/30       | Black/Grey |
| 1/2"       | 15.8            | 16.3  | 20.8             | 21.3  | 100/50/30       |            |
| 3/4"       | 20.7            | 21.3  | 26.0             | 26.7  | 100/50/30       |            |
| 1"         | 26.4            | 27.0  | 32.8             | 33.4  | 100/50/30       |            |
| 1 1/4"     | 34.6            | 35.8  | 41.4             | 42.2  | 30/15           |            |
| 1 1/2"     | 39.8            | 40.6  | 47.4             | 48.3  | 30/15           |            |
| 2"         | 51.3            | 51.9  | 59.4             | 60.3  | 15/7.5          |            |
| 2 1/2"     | 62.9            | 63.6  | 72.1             | 73.2  | 10/7.5          |            |
| 3"         | 76.0            | 78.7  | 87.9             | 89.0  | 10/7.5          |            |
| 4"         | 98.0            | 102.5 | 113.3            | 114.3 | 10/7.5          |            |

Other length of per coil also available

**PVC Coated Flexible Conduit, Grey Color**  
To South American Market



| Trade Size | Inside Dia. (mm) |                   | Coil Length (m) |
|------------|------------------|-------------------|-----------------|
|            | Inside Dia. (mm) | Outside Dia. (mm) |                 |
| 3/8"       | 12               | 16.5              | 100/50/30       |
| 1/2"       | 16               | 21                | 100/50/30       |
| 3/4"       | 20               | 25                | 100/50/30       |
| 1"         | 26               | 32                | 100/50/30       |
| 1 1/4"     | 35               | 41                | 50/25/15        |
| 1 1/2"     | 40               | 49                | 50/25/15        |
| 2"         | 51               | 60                | 30/15/7.5       |
| 2 1/2"     | 64               | 72                | 15/7.5          |
| 3"         | 77               | 86                | 15/7.5          |
| 4"         | 101              | 113               | 15/7.5          |

Other length of per coil also available

**Liquid Tight Connector Straight-**  
Die Cast Zinc



| Cat.No.       | Cat.No.  | Conduit Size |
|---------------|----------|--------------|
| Non-insulated |          |              |
| SLT-038       | SLT-038I | 3/8"         |
| SLT-050       | SLT-050I | 1/2"         |
| SLT-075       | SLT-075I | 3/4"         |
| SLT-100       | SLT-100I | 1"           |
| SLT-125       | SLT-125I | 1 1/4"       |
| SLT-150       | SLT-150I | 1 1/2"       |
| SLT-200       | SLT-200I | 2"           |
| SLT-250       | SLT-250I | 2 1/2"       |
| SLT-300       | SLT-300I | 3"           |
| SLT-400       | SLT-400I | 4"           |
| SLT-600       | SLT-600I | 6"           |

**90° Liquid Tight Connector-**  
Die Cast Zinc



| Cat.No.       | Cat.No.  | Conduit Size |
|---------------|----------|--------------|
| Non-insulated |          |              |
| ALT-038       | ALT-038I | 3/8"         |
| ALT-050       | ALT-050I | 1/2"         |
| ALT-075       | ALT-075I | 3/4"         |
| ALT-100       | ALT-100I | 1"           |
| ALT-125       | ALT-125I | 1 1/4"       |
| ALT-150       | ALT-150I | 1 1/2"       |
| ALT-200       | ALT-200I | 2"           |
| ALT-250       | ALT-250I | 2 1/2"       |
| ALT-300       | ALT-300I | 3"           |
| ALT-400       | ALT-400I | 4"           |



**Liquid Tight Connector Straight-**  
Malleable Iron



| Cat.No.       | Cat.No.   | Conduit Size |
|---------------|-----------|--------------|
| Non-insulated | Insulated |              |
| SLT-038M      | SLT-038MI | 3/8"         |
| SLT-050M      | SLT-050MI | 1/2"         |
| SLT-075M      | SLT-075MI | 3/4"         |
| SLT-100M      | SLT-100MI | 1"           |
| SLT-125M      | SLT-125MI | 1 1/4"       |
| SLT-150M      | SLT-150MI | 1 1/2"       |
| SLT-200M      | SLT-200MI | 2"           |

**Grounding Liquid Tight Connector Straight-**  
Malleable Iron



| Cat.No.       | Cat.No.   | Conduit Size |
|---------------|-----------|--------------|
| Non-insulated | Insulated |              |
| GSLT-038      | GSLT-038I | 3/8"         |
| GSLT-050      | GSLT-050I | 1/2"         |
| GSLT-075      | GSLT-075I | 3/4"         |
| GSLT-100      | GSLT-100I | 1"           |
| GSLT-125      | GSLT-125I | 1 1/4"       |
| GSLT-150      | GSLT-150I | 1 1/2"       |
| GSLT-200      | GSLT-200I | 2"           |

**Screw-in Connectors-**  
Die Cast Zinc or Aluminum



| Cat.No. | Cat.No.  | Conduit Size |
|---------|----------|--------------|
| Zinc    | Aluminum |              |
| XC-038  | XC-038A  | 3/8"         |
| XC-050  | XC-050A  | 1/2"         |
| XC-075  | XC-075A  | 3/4"         |
| XC-100  | XC-100A  | 1"           |

**Screw-in Couplings-**  
Die Cast Zinc



| Cat.No. | Conduit Size |
|---------|--------------|
| XK-050  | 1/2"         |
| XK-075  | 3/4"         |
| XK-100  | 1"           |

**45 ° Liquid Tight Connector-**  
Malleable Iron



| Cat.No.       | Cat.No.    | Conduit Size |
|---------------|------------|--------------|
| Non-insulated | Insulated  |              |
| ALT-03845     | ALT-03845I | 3/8"         |
| ALT-05045     | ALT-05045I | 1/2"         |
| ALT-07545     | ALT-07545I | 3/4"         |
| ALT-10045     | ALT-10045I | 1"           |
| ALT-12545     | ALT-12545I | 1 1/4"       |
| ALT-15045     | ALT-15045I | 1 1/2"       |
| ALT-20045     | ALT-20045I | 2"           |

**45 ° Grounding Liquid Tight Connector-**  
Malleable Iron



| Cat.No.       | Cat.No.     | Conduit Size |
|---------------|-------------|--------------|
| Non-insulated | Insulated   |              |
| GALT-03845    | GALT-03845I | 3/8"         |
| GALT-05045    | GALT-05045I | 1/2"         |
| GALT-07545    | GALT-07545I | 3/4"         |
| GALT-10045    | GALT-10045I | 1"           |
| GALT-12545    | GALT-12545I | 1 1/4"       |
| GALT-15045    | GALT-15045I | 1 1/2"       |
| GALT-20045    | GALT-20045I | 2"           |

**One Screw Duplex Connector**  
Die Cast Zinc



| Cat.No.       | Cable Size |
|---------------|------------|
| Non-insulated |            |
| OSDC-038      | 3/8"       |

**Saddle type Connector-**  
Die Cast Zinc



| Cat.No.       | Cable Size |
|---------------|------------|
| Non-insulated |            |
| STFC-038      | 3/8"       |

**90 ° Liquid Tight Connector-**  
Malleable Iron



| Cat.No.       | Cat.No.    | Conduit Size |
|---------------|------------|--------------|
| Non-insulated | Insulated  |              |
| ALT-03890     | ALT-03890I | 3/8"         |
| ALT-05090     | ALT-05090I | 1/2"         |
| ALT-07590     | ALT-07590I | 3/4"         |
| ALT-10090     | ALT-10090I | 1"           |
| ALT-12590     | ALT-12590I | 1 1/4"       |
| ALT-15090     | ALT-15090I | 1 1/2"       |
| ALT-20090     | ALT-20090I | 2"           |

**90 ° Grounding Liquid Tight Connector-**  
Malleable Iron



| Cat.No.       | Cat.No.     | Conduit Size |
|---------------|-------------|--------------|
| Non-insulated | Insulated   |              |
| GALT-03890    | GALT-03890I | 3/8"         |
| GALT-05090    | GALT-05090I | 1/2"         |
| GALT-07590    | GALT-07590I | 3/4"         |
| GALT-10090    | GALT-10090I | 1"           |
| GALT-12590    | GALT-12590I | 1 1/4"       |
| GALT-15090    | GALT-15090I | 1 1/2"       |
| GALT-20090    | GALT-20090I | 2"           |

**NM Cable Connector-**  
Die Cast Zinc



| Cat.No.       | Cable Size |
|---------------|------------|
| Non-insulated |            |
| RTCC-050      | 1/2"       |
| RTCC-075      | 3/4"       |
| RTCC-100      | 1"         |

**Combination Cable Connector-**  
Die Cast Zinc



| Cat.No.       | Cable Size      |
|---------------|-----------------|
| Non-insulated |                 |
| SCCC-038      | 3/8" (1/2" KO.) |

**Liquid Tight Connector Straight-**  
Galvanized Steel



| Cat.No.       | Cat.No.   | Conduit Size |
|---------------|-----------|--------------|
| Non-insulated | Insulated |              |
| SLT-038S      | SLT-038SI | 3/8"         |
| SLT-050S      | SLT-050SI | 1/2"         |
| SLT-075S      | SLT-075SI | 3/4"         |
| SLT-100S      | SLT-100SI | 1"           |
| SLT-125S      | SLT-125SI | 1 1/4"       |
| SLT-150S      | SLT-150SI | 1 1/2"       |
| SLT-200S      | SLT-200SI | 2"           |

**Liquid Tight Connector Male-**  
SS304



| Cat.No.   | Conduit Size |
|-----------|--------------|
| Insulated |              |
| SLT-050SS | 1/2"         |
| SLT-075SS | 3/4"         |
| SLT-100SS | 1"           |
| SLT-125SS | 1 1/4"       |
| SLT-150SS | 1 1/2"       |
| SLT-200SS | 2"           |

**Two Screw Duplex Connector-**  
Aluminum or Zinc Die Cast



Thread x Inner Dia.of Flex. Conduit

| Cat.No.       | Conduit Size |
|---------------|--------------|
| Non-Insulated |              |
| DPC-050       | 1/2" x 16mm  |
| DPC-075       | 3/4" X 20mm  |
| DPC-100       | 1" X 25mm    |

**Flex Conduit Connector, to Thailand Market**  
Zinc Die Cast



Thread x Inner Dia.of Flex. Conduit

| Cat.No.       | Conduit Size  |
|---------------|---------------|
| Non-Insulated |               |
| FCC-050       | 1/2" x 12.5mm |
| FCC-075       | 3/4" x 18.0mm |
| FCC-100       | 1" x 25.5mm   |



**Non Metallic Liquid Tight Conduit**

| Trade Size | Inside Dia. (mm) | Outside Dia. (mm) | Coil Length (m) |
|------------|------------------|-------------------|-----------------|
| 1/2"       | 16               | 21                | 20              |
| 3/4"       | 20               | 26                | 15              |
| 1"         | 25               | 32                | 10              |
| 1 1/4"     | 32               | 40                | 10              |
| 1 1/2"     | 40               | 48                | 5               |
| 2"         | 51               | 60                | 5               |

**NM Liquid Tight Connector Straight - 6/6 Nylon**



| Cat.No.  | Conduit Size |
|----------|--------------|
| SLT-038N | 3/8"         |
| SLT-050N | 1/2"         |
| SLT-075N | 3/4"         |
| SLT-100N | 1"           |
| SLT-125N | 1 1/4"       |
| SLT-150N | 1 1/2"       |
| SLT-200N | 2"           |

**90° NM Liquid Tight Connector- 6/6 Nylon**



| Cat.No.  | Conduit Size |
|----------|--------------|
| ALT-038N | 3/8"         |
| ALT-050N | 1/2"         |
| ALT-075N | 3/4"         |
| ALT-100N | 1"           |
| ALT-125N | 1 1/4"       |
| ALT-150N | 1 1/2"       |
| ALT-200N | 2"           |

**Galvanized Flexible Conduit, to Philippines Market**



| Trade Size | Inside Dia. (mm) | Outside Dia. (mm) | Coil Length (m) |
|------------|------------------|-------------------|-----------------|
| 3/8"       | 13               | 15.5              | 30              |
| 1/2"       | 16               | 19                | 30              |
| 3/4"       | 20               | 23                | 30              |
| 1"         | 25               | 29                | 30              |
| 1 1/4"     | 32               | 37                | 30              |
| 1 1/2"     | 38               | 43                | 30              |
| 2"         | 51               | 57.5              | 30              |

**SS304 Flexible Wire Braiding General Conduit**



| Trade Size | Inside Dia. (mm) | Outside Dia. (mm) | Coil Length (m) |
|------------|------------------|-------------------|-----------------|
| 3/8"       | 12               | 19                | 50              |
| 1/2"       | 16               | 23                | 30              |
| 3/4"       | 20               | 28                | 30              |
| 1"         | 25               | 34                | 30              |
| 1 1/4"     | 32               | 42                | 15              |
| 1 1/2"     | 38               | 49                | 15              |
| 2"         | 51               | 62                | 15              |
| 2 1/2"     | 63               | 75                | 10              |
| 3"         | 75               | 89                | 10              |
| 4"         | 100              | 116               | 10              |

**JS Type Flexible Steel Conduit- Pre-galvanized**

**JL Type PVC Coated Flexible Conduit- Grey Color**



| Trade Size | Inside Dia. (mm) | Outside Dia. (mm) | Coil Length (m) |
|------------|------------------|-------------------|-----------------|
| 3/8"       | 12               | 16                | 100/50/30       |
| 1/2"       | 16               | 19                | 100/50/30       |
| 3/4"       | 20               | 24                | 100/50/30       |
| 1"         | 25               | 30                | 100/50/30       |
| 1 1/4"     | 32               | 38                | 50/25/20        |
| 1 1/2"     | 38               | 45                | 50/25/15        |
| 2"         | 51               | 59                | 50/15/10        |
| 2 1/2"     | 63               | 70                | 20/15/10        |
| 3"         | 75               | 84                | 20/15/10        |
| 4"         | 100              | 112               | 20/15/10        |
| 5"         | 125              | 137               | 5               |
| 6"         | 150              | 162               | 5               |

Other length of per coil also available

**PVC Coated Flexible Conduit-Halogen Free Black Color**



| Trade Size | Inside Dia. (mm) | Outside Dia. (mm) | Coil Length (m) |
|------------|------------------|-------------------|-----------------|
| 3/8"       | 12               | 17                | 50              |
| 1/2"       | 16               | 21                | 30              |
| 3/4"       | 20               | 26                | 30              |
| 1"         | 25               | 32                | 30              |
| 1 1/4"     | 32               | 40                | 15              |
| 1 1/2"     | 38               | 47                | 15              |
| 2"         | 51               | 61                | 15              |
| 2 1/2"     | 63               | 72                | 10              |
| 3"         | 75               | 88                | 10              |
| 4"         | 100              | 114               | 10              |

Other length of per coil also available

**Metal Ferrule- Galvanized Steel**



| Cat.No. | Conduit Size |
|---------|--------------|
| MF-014  | 1/4"         |
| MF-038  | 3/8"         |
| MF-050  | 1/2"         |
| MF-075  | 3/4"         |
| MF-100  | 1"           |
| MF-125  | 1 1/4"       |
| MF-150  | 1 1/2"       |
| MF-200  | 2"           |
| MF-250  | 2 1/2"       |
| MF-300  | 3"           |
| MF-400  | 4"           |
| MF-500  | 5"           |
| MF-600  | 6"           |

**Metal Ferrule Screw Type- Galvanized Steel**



| Cat.No.  | Conduit Size |
|----------|--------------|
| LXYQ-014 | 1/4"         |
| LXYQ-038 | 3/8"         |
| LXYQ-050 | 1/2"         |
| LXYQ-075 | 3/4"         |
| LXYQ-100 | 1"           |
| LXYQ-125 | 1 1/4"       |
| LXYQ-150 | 1 1/2"       |
| LXYQ-200 | 2"           |
| LXYQ-250 | 2 1/2"       |
| LXYQ-300 | 3"           |
| LXYQ-400 | 4"           |
| LXYQ-500 | 5"           |
| LXYQ-600 | 6"           |

**DPJ Connector, Flex Conduit to Box-**  
Die Cast Zinc



| Cat.No. | Conduit Size |
|---------|--------------|
| DPJ-014 | 1/4"         |
| DPJ-038 | 3/8"         |
| DPJ-050 | 1/2"         |
| DPJ-075 | 3/4"         |
| DPJ-100 | 1"           |
| DPJ-125 | 1 1/4"       |
| DPJ-150 | 1 1/2"       |
| DPJ-200 | 2"           |
| DPJ-250 | 2 1/2"       |
| DPJ-300 | 3"           |
| DPJ-400 | 4"           |
| DPJ-500 | 5"           |
| DPJ-600 | 6"           |



G thread, other thread NPT, Metric, PG also available

**DKJ Connector, Flex Conduit to Steel Pipe-**



| Cat.No. | Conduit Size |
|---------|--------------|
| DKJ-038 | 3/8"         |
| DKJ-050 | 1/2"         |
| DKJ-075 | 3/4"         |
| DKJ-100 | 1"           |
| DKJ-125 | 1 1/4"       |
| DKJ-150 | 1 1/2"       |
| DKJ-200 | 2"           |
| DKJ-250 | 2 1/2"       |
| DKJ-300 | 3"           |
| DKJ-400 | 4"           |
| DKJ-500 | 5"           |
| DKJ-600 | 6"           |



**DNJ Connector, Flex Conduit to Box 45° -**



| Cat.No. | Conduit Size |
|---------|--------------|
| DNJ-038 | 3/8"         |
| DNJ-050 | 1/2"         |
| DNJ-075 | 3/4"         |
| DNJ-100 | 1"           |
| DNJ-125 | 1 1/4"       |
| DNJ-150 | 1 1/2"       |
| DNJ-200 | 2"           |
| DNJ-250 | 2 1/2"       |
| DNJ-300 | 3"           |
| DNJ-400 | 4"           |



**DPN Connector, Flex Conduit to Threaded Conduit-**  
Die Cast Zinc



| Cat.No. | Conduit Size |
|---------|--------------|
| DPN-014 | 1/4"         |
| DPN-038 | 3/8"         |
| DPN-050 | 1/2"         |
| DPN-075 | 3/4"         |
| DPN-100 | 1"           |
| DPN-125 | 1 1/4"       |
| DPN-150 | 1 1/2"       |
| DPN-200 | 2"           |
| DPN-250 | 2 1/2"       |
| DPN-300 | 3"           |
| DPN-400 | 4"           |
| DPN-500 | 5"           |
| DPN-600 | 6"           |



G thread, other thread NPT, Metric, PG also available

**DGJ Connector, Flex Conduit to Flex Conduit-**



| Cat.No. | Conduit Size |
|---------|--------------|
| DGJ-038 | 3/8"         |
| DGJ-050 | 1/2"         |
| DGJ-075 | 3/4"         |
| DGJ-100 | 1"           |
| DGJ-125 | 1 1/4"       |
| DGJ-150 | 1 1/2"       |
| DGJ-200 | 2"           |
| DGJ-250 | 2 1/2"       |
| DGJ-300 | 3"           |
| DGJ-400 | 4"           |
| DGJ-500 | 5"           |
| DGJ-600 | 6"           |



**DWJ Connector, Flex Conduit to Box 90° -**



| Cat.No. | Conduit Size |
|---------|--------------|
| DWJ-038 | 3/8"         |
| DWJ-050 | 1/2"         |
| DWJ-075 | 3/4"         |
| DWJ-100 | 1"           |
| DWJ-125 | 1 1/4"       |
| DWJ-150 | 1 1/2"       |
| DWJ-200 | 2"           |
| DWJ-250 | 2 1/2"       |
| DWJ-300 | 3"           |
| DWJ-400 | 4"           |



# Corrugated Flexible Conduit

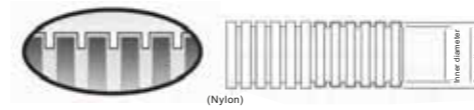

| Trade Size     | Inner Dia.xOuter (mm) | Curved Radius (mm) | Flame Retardant FPA6 | PA6       | PE        | PP        |
|----------------|-----------------------|--------------------|----------------------|-----------|-----------|-----------|
| AD10.0(1/4")   | 6.5x10.0              | 13                 | FPA-AD10.0           | PA-AD10.0 | PE-AD10.0 | PP-AD10.0 |
| AD11.6         | 8.0x11.6              | 16                 | FPA-AD11.6           | PA-AD11.6 | PE-AD11.6 | PP-AD11.6 |
| AD13.0(5/16")  | 10.0x13.0             | 20                 | FPA-AD13.0           | PA-AD13.0 | PE-AD13.0 | PP-AD13.0 |
| AD15.8(3/8")   | 12.0x15.8             | 35                 | FPA-AD15.8           | PA-AD15.8 | PE-AD15.8 | PP-AD15.8 |
| AD18.5         | 14.3x18.5             | 40                 | FPA-AD18.5           | PA-AD18.5 | PE-AD18.5 | PP-AD18.5 |
| AD21.2(1/2")   | 17.0x21.2             | 45                 | FPA-AD21.2           | PA-AD21.2 | PE-AD21.2 | PP-AD21.2 |
| AD25.0         | 21.0x25.0             | 50                 | FPA-AD25.0           | PA-AD25.0 | PE-AD25.0 | PP-AD25.0 |
| AD28.5(3/4")   | 23.0x28.5             | 55                 | FPA-AD28.5           | PA-AD28.5 | PE-AD28.5 | PP-AD28.5 |
| AD34.5(1")     | 29.0x34.5             | 65                 | FPA-AD34.5           | PA-AD34.5 | PE-AD34.5 | PP-AD34.5 |
| AD42.5(1-1/4") | 36.0x42.5             | 90                 | FPA-AD42.5           | PA-AD42.5 | PE-AD42.5 | PP-AD42.5 |
| AD54.5         | 48.0x54.5             | 100                | FPA-AD54.5           | PA-AD54.5 | PE-AD54.5 | PP-AD54.5 |



**Straight Quick Connector**  
Materials: Nylon  
Thread: Metric / PG / G Thread  
Protection Classification: IP66  
Size: Fit to AD10.0 to AD54.5 Flex Pipes



**Bend Angle Quick Connector**  
Materials: Nylon  
Thread: Metric / PG / G Thread  
Protection Classification: IP66  
Size: Fit to AD10.0 to AD54.5 Flex Pipes



**Mounting Clip**  
Materials: Nylon  
Protection Classification: IP66  
Size: Fit to AD10.0 to AD54.5 Flex Pipes



**Mounting Clip with Lid**  
Materials: Nylon  
Protection Classification: IP66  
Size: Fit to AD10.0 to AD54.5 Flex Pipes



**Butt Joint Connector**  
Materials: TPR Rubber  
Protection Classification: IP66  
Size: Fit to AD10.0 to AD54.5 Flex Pipes



**3-Way T-Shaped Pipe Joint**  
Materials: TPR Rubber  
Protection Classification: IP66  
Size: Fit to AD10.0 to AD54.5 Flex Pipes



## Strut Channels

### 41x41 Plain/Slotted Unistrut Channel

- PL: Plain
- PG: Pre-galvanized
- EG: Electro-galvanized
- HDG: Hot dip galvanized
- SS: Stainless Steel

| Dim.   |         | Thickness |     |
|--------|---------|-----------|-----|
| in     | mm      | gauge     | mm  |
| 1 5/8" | 41 X 41 | 12        | 2.5 |
| 1 5/8" | 41 X 41 | 13        | 2.3 |
| 1 5/8" | 41 X 41 | 14        | 2.0 |
| 1 5/8" | 41 X 41 | 15        | 1.8 |
| 1 5/8" | 41 X 41 | 16        | 1.5 |
| 1 5/8" | 41 X 41 | 17        | 1.3 |
| 1 5/8" | 41 X 41 | 18        | 1.2 |

| Dim.             |         | Thickness |     |
|------------------|---------|-----------|-----|
| in               | mm      | gauge     | mm  |
| 1 5/8" X 1 3/16" | 41 X 21 | 12        | 2.5 |
| 1 5/8" X 1 3/16" | 41 X 21 | 13        | 2.3 |
| 1 5/8" X 1 3/16" | 41 X 21 | 14        | 2.0 |
| 1 5/8" X 1 3/16" | 41 X 21 | 15        | 1.8 |
| 1 5/8" X 1 3/16" | 41 X 21 | 16        | 1.5 |
| 1 5/8" X 1 3/16" | 41 X 21 | 17        | 1.3 |
| 1 5/8" X 1 3/16" | 41 X 21 | 18        | 1.2 |

Standard lengths 10ft. / 3.0meter  
Other length,thickness available.

### Cantilever Arm

- EG / HDG

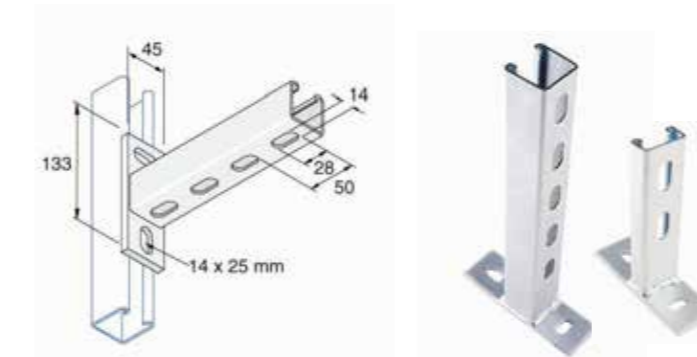

### Channel End Cap

- Plastic

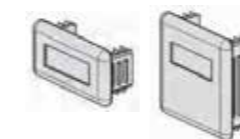

| Cat.No. | Channel Size |
|---------|--------------|
| EC-1    | 41x21        |
| EC-2    | 41x41        |

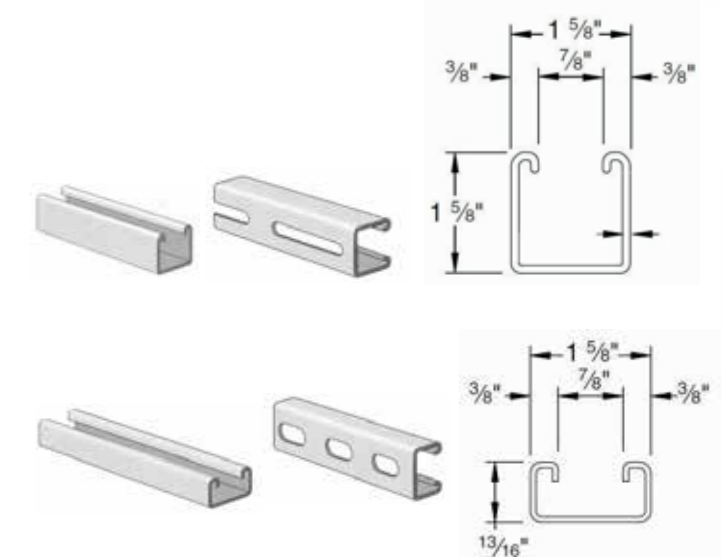

Slot Size for choice :

|             |
|-------------|
| 14.3x28.6mm |
| 12x40mm     |
| 12x28mm     |
| 14x30mm     |
| 11x35mm     |

\* other size also available

| Cat.No.        | "A" (mm) | Channel Size (mm) |
|----------------|----------|-------------------|
| CA-412120-150S | 150      | 41x21x2.0         |
| CA-412120-200S | 200      | 41x21x2.0         |
| CA-412120-300S | 300      | 41x21x2.0         |
| CA-412120-450S | 450      | 41x21x2.0         |

| Cat.No.        | "A" (mm) | Channel Size (mm) |
|----------------|----------|-------------------|
| CA-414120-150S | 150      | 41x41x2.0         |
| CA-414120-300S | 300      | 41x41x2.0         |
| CA-414120-450S | 450      | 41x41x2.0         |
| CA-414120-600S | 600      | 41x41x2.0         |

| Cat.No.        | "A" (mm) | Channel Size (mm) |
|----------------|----------|-------------------|
| CA-414125-150S | 150      | 41x41x2.5         |
| CA-414125-300S | 300      | 41x41x2.5         |
| CA-414125-450S | 450      | 41x41x2.5         |
| CA-414125-600S | 600      | 41x41x2.5         |
| CA-414125-700S | 700      | 41x41x2.5         |

Other length also available.

## Fasteners

### All Thread Rods

UNC Thread

- PL: Plain
- EG: Electro-Galvanized
- HDG: Hot Dip Galvanized
- SS: Stainless Steel



Standard lengths 10ft./3.0meter  
Other length also available.

| Cat.No. | Thread Size |
|---------|-------------|
| TR-14   | 1/4"-20     |
| TR-516  | 5/16"-18    |
| TR-38   | 3/8"-16     |
| TR-12   | 1/2"-13     |
| TR-58   | 5/8"-11     |
| TR-34   | 3/4"-10     |
| TR-78   | 7/8"-9      |
| TR-1    | 1"-8        |

### Drop in Anchor

UNC Thread

- Zinc / Yellow Plated

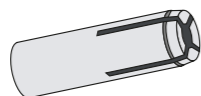

| Cat.No. | Thread Size | Drill Diameter | Length (In) | Weight kgs/KPCS |
|---------|-------------|----------------|-------------|-----------------|
| DIA-14  | 1/4"-20     | 3/8"           | 1"          | 9.6             |
| DIA-516 | 5/16"-18    | 3/8"           | 1-1/4"      | 9.8             |
| DIA-38  | 3/8"-16     | 1/2"           | 1-9/16"     | 25              |
| DIA-12  | 1/2"-13     | 5/8"           | 2"          | 50              |
| DIA-58  | 5/8"-11     | 7/8"           | 2-1/2"      | 135             |
| DIA-34  | 3/4"-10     | 1"             | 3-3/18"     | 196             |

### Rod Coupler

UNC Thread

- Zinc Plated



| Cat.No. | Thread Size | Across Flat | Length (In) | Weight kgs/KPCS |
|---------|-------------|-------------|-------------|-----------------|
| RC-14   | 1/4"-20     | 3/8"        | 7/8"        | 9               |
| RC-516  | 5/16"-18    | 1/2"        | 1-1/8"      | 21              |
| RC-38   | 3/8"-16     | 9/16"       | 1-1/8"      | 19              |
| RC-12   | 1/2"-13     | 11/16"      | 1-3/4"      | 52              |
| RC-58   | 5/8"-11     | 13/16"      | 2-1/8"      | 82              |
| RC-34   | 3/4"-10     | 1"          | 2-1/4"      | 136             |

### Channel Nuts

UNC Thread

- EG: Electro-Galvanized
- HDG: Hot Dip Galvanized
- SS: Stainless Steel



Long Spring

| Thread Size | Nut Specification |          | Thickness mm |
|-------------|-------------------|----------|--------------|
|             | Length mm         | Width mm |              |
| 1/4"-20     | 34.5              | 19       | 6.0          |
| 5/16"-18    | 34.5              | 19       | 6.0/8.0      |
| 3/8"-16     | 34.5              | 19       | 8.0/9.2      |
| 7/16"-14    | 34.5              | 19       | 8.0/9.2      |
| 1/2"-13     | 34.5              | 19       | 9.2/11.8     |
| 5/8"-11     | 34.5              | 30       | 11.0         |
| 3/4"-10     | 34.5              | 30       | 11.0         |
| 7/8"-9      | 34.5              | 30       | 11.0         |

### U Bolts

- EG: Electro-Galvanized



| Size   | Bolts  |        | Pipe Size mm |
|--------|--------|--------|--------------|
|        | A type | B type |              |
| 1/2"   | 1/4"   | 3/8"   | 21.34        |
| 3/4"   | 1/4"   | 3/8"   | 26.67        |
| 1"     | 1/4"   | 3/8"   | 33.40        |
| 1 1/4" | 1/4"   | 3/8"   | 42.16        |
| 1 1/2" | 1/4"   | 3/8"   | 48.26        |
| 2"     | 1/4"   | 3/8"   | 60.33        |
| 2 1/2" | 3/8"   | 1/2"   | 73.03        |
| 3"     | 3/8"   | 1/2"   | 88.90        |
| 3 1/2" | 3/8"   | 1/2"   | 101.6        |
| 4"     | 3/8"   | 1/2"   | 114.3        |
| 5"     | 3/8"   | 1/2"   | 141.3        |
| 6"     | 3/8"   | 1/2"   | 168.3        |
| 8"     | 3/8"   | 1/2"   | 219.1        |
| 10"    | 3/8"   | 1/2"   | 273.1        |
| 12"    | 3/8"   | 1/2"   | 323.9        |

### Steel Beam Clamp

- Standard finish—Galvanized



| Cat.No. | Rods Size | Open Size |
|---------|-----------|-----------|
| TMBC-38 | 3/8"-16   | 1-1/4"    |
| TMBC-12 | 1/2"-13   | 1-1/4"    |

### Standard Top Hat Punched Din Rail

- Yellow Zinc Plated

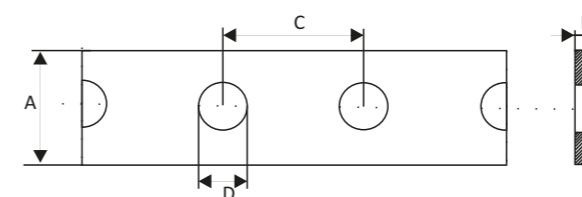
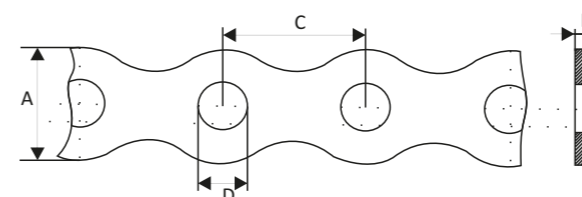
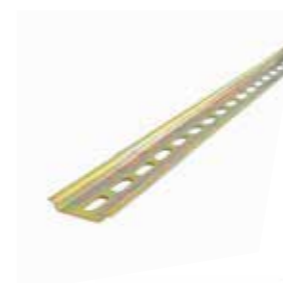

## Fasteners

### Top Mount Steel Beam Clamp

- Standard finish—Galvanized or Plain



| Cat.No. | Rods Size | Open Size |
|---------|-----------|-----------|
| BC-14   | 1/4"-20   | 3/4"      |
| BC-38   | 3/8"-16   | 1-1/4"    |

| Plain   |        | Slotted  |        |
|---------|--------|----------|--------|
| Cat No. | Length | Cat No.  | Length |
| KG-3510 | 1.0m   | KG-3510S | 1.0m   |
| KG-3520 | 2.0m   | KG-3520S | 2.0m   |

\* Available in full and perforated versions, in various lengths.

### Perforated Banding

- Pre-galvanized
- PVC Box or Cable Tie packing
- Application: Designed for using to secure cable, pipe duct and conduit, evenly-spaced holes allow fastening with screws or nuts and bolts

### Rounded Gal. Perforated Banding

| Cat. No.   | AXB (mm) | D (mm) | C (mm) | Lth's/Roll |
|------------|----------|--------|--------|------------|
| RPB-120810 | 12x0.8   | 5.0    | 14     | 10M        |
| RPB-170810 | 17x0.8   | 7.0    | 20     | 10M        |
| RPB-261010 | 26x1.0   | 8.0    | 25     | 10M        |

### Straight Gal. Perforated Banding

| Cat. No.   | AXB (mm) | D (mm) | C (mm) | Lth's/Roll |
|------------|----------|--------|--------|------------|
| SPB-120810 | 12x0.8   | 5.0    | 8      | 10M        |
| SPB-170810 | 17x0.8   | 7.0    | 12     | 10M        |
| SPB-200810 | 20x0.8   | 8.0    | 12     | 10M        |
| SPB-261010 | 26x1.0   | 8.0    | 12     | 10M        |

## Strut Channel Accessories

### Standard Clevis Hanger

- Electro-Galvanized



| Cat.No.   | Conduit Size | Rod Size |
|-----------|--------------|----------|
| HDCH-050  | 1/2"         | 1/4"     |
| HDCH-075  | 3/4"         | 1/4"     |
| HDCH-100  | 1"           | 1/4"     |
| HDCH-125  | 1 1/4"       | 1/4"     |
| HDCH-150  | 1 1/2"       | 1/4"     |
| HDCH-200  | 2"           | 1/4"     |
| HDCH-250  | 2 1/2"       | 3/8"     |
| HDCH-300  | 3"           | 3/8"     |
| HDCH-350  | 3 1/2"       | 3/8"     |
| HDCH-400  | 4"           | 3/8"     |
| HDCH-500  | 5"           | 1/2"     |
| HDCH-600  | 6"           | 1/2"     |
| HDCH-800  | 8"           | 5/8"     |
| HDCH-1000 | 10"          | 3/4"     |
| HDCH-1200 | 12"          | 3/4"     |

### Swivel Band Hanger

- Pre-Galvanized
- Electro-Galvanized
- Copper Plated



| Cat.No. | Conduit Size | Rod Size | O.D. mm |
|---------|--------------|----------|---------|
| S-050   | 1/2"         | 3/8"     | 21.34   |
| S-075   | 3/4"         | 3/8"     | 26.67   |
| S-100   | 1"           | 3/8"     | 33.40   |
| S-125   | 1 1/4"       | 3/8"     | 42.16   |
| S-150   | 1 1/2"       | 3/8"     | 48.26   |
| S-200   | 2"           | 3/8"     | 60.33   |
| S-250   | 2 1/2"       | 3/8"     | 73.03   |
| S-300   | 3"           | 3/8"     | 88.90   |
| S-350   | 3 1/2"       | 3/8"     | 101.6   |
| S-400   | 4"           | 3/8"     | 114.3   |
| S-500   | 5"           | 1/2"     | 141.3   |
| S-600   | 6"           | 1/2"     | 168.3   |
| S-800   | 8"           | 1/2"     | 219.1   |

### Riser Clamps

- Electro-Galvanized
- Copper Plated



| Cat.No. | Conduit Size | Cat.No. | Conduit Size |
|---------|--------------|---------|--------------|
| RC-050  | 1/2"         | RC-500  | 5"           |
| RC-075  | 3/4"         | RC-600  | 6"           |
| RC-100  | 1"           | RC-800  | 8"           |
| RC-125  | 1 1/4"       | RC-1000 | 10"          |
| RC-150  | 1 1/2"       | RC-1200 | 12"          |
| RC-200  | 2"           | RC-1400 | 14"          |
| RC-250  | 2 1/2"       | RC-1600 | 16"          |
| RC-300  | 3"           | RC-1800 | 18"          |
| RC-350  | 3 1/2"       | RC-2000 | 20"          |
| RC-400  | 4"           |         |              |

### Universal Strut Clamps, Pre-assembled For EMT, IMC, GC, Pipe, or O.D. Tube.

- EG: Electro-Galvanized



| Cat.No. | Conduit Size | O.D. mm     |
|---------|--------------|-------------|
| SC-050U | 1/2"         | 17.93-21.34 |
| SC-075U | 3/4"         | 23.42-26.67 |
| SC-100U | 1"           | 29.54-33.40 |
| SC-125U | 1 1/4"       | 38.35-42.16 |
| SC-150U | 1 1/2"       | 44.20-48.26 |
| SC-200U | 2"           | 55.80-60.33 |

### Cushion Clamp

- Yellow Zinc Plated
- With TPR Sleeve



| Cat.No. | Tube O.D. |
|---------|-----------|
| SC-14   | 1/4"      |
| SC-38   | 3/8"      |
| SC-12   | 1/2"      |
| SC-58   | 5/8"      |
| SC-34   | 3/4"      |
| SC-78   | 7/8"      |
| SC-118  | 1 1/8"    |
| SC-138  | 1 3/8"    |
| SC-158  | 1 5/8"    |
| SC-218  | 2 1/8"    |
| SC-258  | 2 3/8"    |
| SC-318  | 3 1/8"    |
| SC-418  | 4 1/8"    |

### One-piece Cable Clamp

- Electro-Galvanized



| Cat.No. | Cable Size mm |
|---------|---------------|
| OPC-14  | 8-14          |
| OPC-16  | 12-16         |
| OPC-20  | 18-22         |
| OPC-26  | 23-27         |
| OPC-32  | 29-33         |
| OPC-40  | 38-40         |
| OPC-46  | 40-46         |
| OPC-52  | 46-52         |
| OPC-58  | 52-58         |
| OPC-66  | 58-66         |
| OPC-70  | 64-70         |
| OPC-78  | 70-78         |
| OPC-90  | 78-95         |

## Strut Channel Accessories

### G Clamp

- Standard finish—Zinc Plated



| Cat.No. | Bolts | Thickness |
|---------|-------|-----------|
| CBC-1   | M8x20 | 2.5mm     |
| CBC-2   | M8x20 | 3.0mm     |
| CBC-3   | M8x25 | 3.0mm     |

### Rigid Straps, Malleable Iron

- Zinc Plated or HDG



| Cat.No. | Conduit Size |
|---------|--------------|
| MRS-038 | 3/8"         |
| MRS-050 | 1/2"         |
| MRS-075 | 3/4"         |
| MRS-100 | 1"           |
| MRS-125 | 1 1/4"       |
| MRS-150 | 1 1/2"       |
| MRS-200 | 2"           |
| MRS-250 | 2 1/2"       |
| MRS-300 | 3"           |
| MRS-350 | 3 1/2"       |
| MRS-400 | 4"           |

### Spring Steel Beam Clamp

- Black Enamel



| Cat.No. | Screw       | Flange      |
|---------|-------------|-------------|
| SSBC-14 | 1/4"-1 1/4" | 1/8" - 1/2" |

### Rigid Clamp Backs, Malleable Iron

- Zinc Plated or HDG



| Cat.No. | Conduit Size |
|---------|--------------|
| MRC-050 | 1/2"         |
| MRC-075 | 3/4"         |
| MRC-100 | 1"           |
| MRC-125 | 1 1/4"       |
| MRC-150 | 1 1/2"       |
| MRC-200 | 2"           |
| MRC-250 | 2 1/2"       |
| MRC-300 | 3"           |
| MRC-350 | 3 1/2"       |
| MRC-400 | 4"           |

### Pipe Clamp with EPDM or without



| Trade Size | D (mm)  | bxS (mm) | M (mm) | G      |        |
|------------|---------|----------|--------|--------|--------|
| 3/8"       | 15-19   | 20x1.5   | M6x20  | M8+M10 | 3/8-16 |
| 1/2"       | 20-25   | 20x1.5   | M6x20  | M8+M10 | 3/8-16 |
| 3/4"       | 26-30   | 20x1.5   | M6x20  | M8+M10 | 3/8-16 |
| 1"         | 32-36   | 20x1.5   | M6x20  | M8+M10 | 3/8-16 |
| 1 1/4"     | 38-43   | 20x1.5   | M6x20  | M8+M10 | 3/8-16 |
| 1 1/2"     | 47-51   | 20x1.5   | M6x20  | M8+M10 | 3/8-16 |
| 2"         | 60-64   | 20x1.5   | M6x20  | M8+M10 | 3/8-16 |
| 2 1/2"     | 75-80   | 20x1.5   | M6x20  | M8+M10 | 3/8-16 |
| 3"         | 87-92   | 20x1.5   | M6x20  | M8+M10 | 3/8-16 |
| 3 1/2"     | 99-105  | 20x1.5   | M6x20  | M8+M10 | 3/8-16 |
| 4"         | 113-118 | 20x1.5   | M6x20  | M8+M10 | 3/8-16 |
| 5"         | 138-142 | 20x1.5   | M6x20  | M8+M10 | 3/8-16 |
| 6"         | 159-166 | 20x1.5   | M6x20  | M8+M10 | 3/8-16 |
| 8"         | 200-212 | 20x1.5   | M6x20  | M8+M10 | 3/8-16 |

## Strut Channel Accessories

### Top Beam Clamps- Malleable Iron

- Standard finish—  
Plain or Galvanized



| Cat.No. | Rod Size | Open Size (mm) |
|---------|----------|----------------|
| 375-38  | 3/8"     | 3/4"           |
| 375-12  | 1/2"     | 3/4"           |

### Beam Clamps- Malleable Iron

- Standard finish—  
Galvanized



| Cat.No. | Rod Size | Open Size (mm) |
|---------|----------|----------------|
| TBC-M06 | M6       | 18.5           |
| TBC-M08 | M8       | 18.5           |
| TBC-M10 | M10      | 20.0           |
| TBC-M12 | M12      | 30.0           |
| TBC-M14 | M14      | 35.0           |
| TBC-M16 | M16      | 35.0           |

### Top Beam Clamps- Malleable Iron

- Standard finish—  
Plain or Galvanized



| Cat.No.  | Rod Size | Open Size |
|----------|----------|-----------|
| BC-3414  | 1/4"     | 3/4"      |
| BC-3438  | 3/8"     | 3/4"      |
| BC-3412  | 1/2"     | 3/4"      |
| BC-11438 | 3/8"     | 1-1/4"    |
| BC-11412 | 1/2"     | 1-1/4"    |

### Universal Beam Clamps- Malleable Iron

- Standard finish—  
Plain or Galvanized



| Cat.No. | Rod Size | Open Size |
|---------|----------|-----------|
| 103-38  | 3/8"     | 3/4"      |
| 103-12  | 1/2"     | 3/4"      |
| 833-38  | 3/8"     | 1-1/8"    |
| 833-12  | 1/2"     | 1-1/8"    |

### Swing Hanger-Steel

- Standard finish—  
Yellow Zinc Plated



| Cat.No.  | Size |
|----------|------|
| SHBC-38  | 3/8" |
| SHBC-50  | 1/2" |
| SHBC-M10 | M10  |
| SHBC-M12 | M12  |

### Wide Mouth Beam Clamps- Malleable Iron

- Standard finish—  
Plain or Galvanized



| Cat.No. | Rods Size | Open Size |
|---------|-----------|-----------|
| 400-38  | 3/8"      | 1-1/4"    |
| 400-12  | 1/2"      | 1-1/4"    |

### Beam Clamps for Mounting Channel

- Standard finish—  
Galvanized



| Cat.No. | A Size |
|---------|--------|
| MCBC-1  | 3-3/8" |
| MCBC-2  | 5"     |

### Steel Beam Clamp

- Standard finish—  
Yellow Zinc Plated



| Cat.No. | Hole Size | Open Size | Bolt        |
|---------|-----------|-----------|-------------|
| BCY-38  | 3/8"-16   | 1-1/4"    | 3/8"x1-1/2" |
| BCY-12  | 1/2"-13   | 1-1/4"    | 1/2"x1-1/2" |

# Electrical Conduit Tools

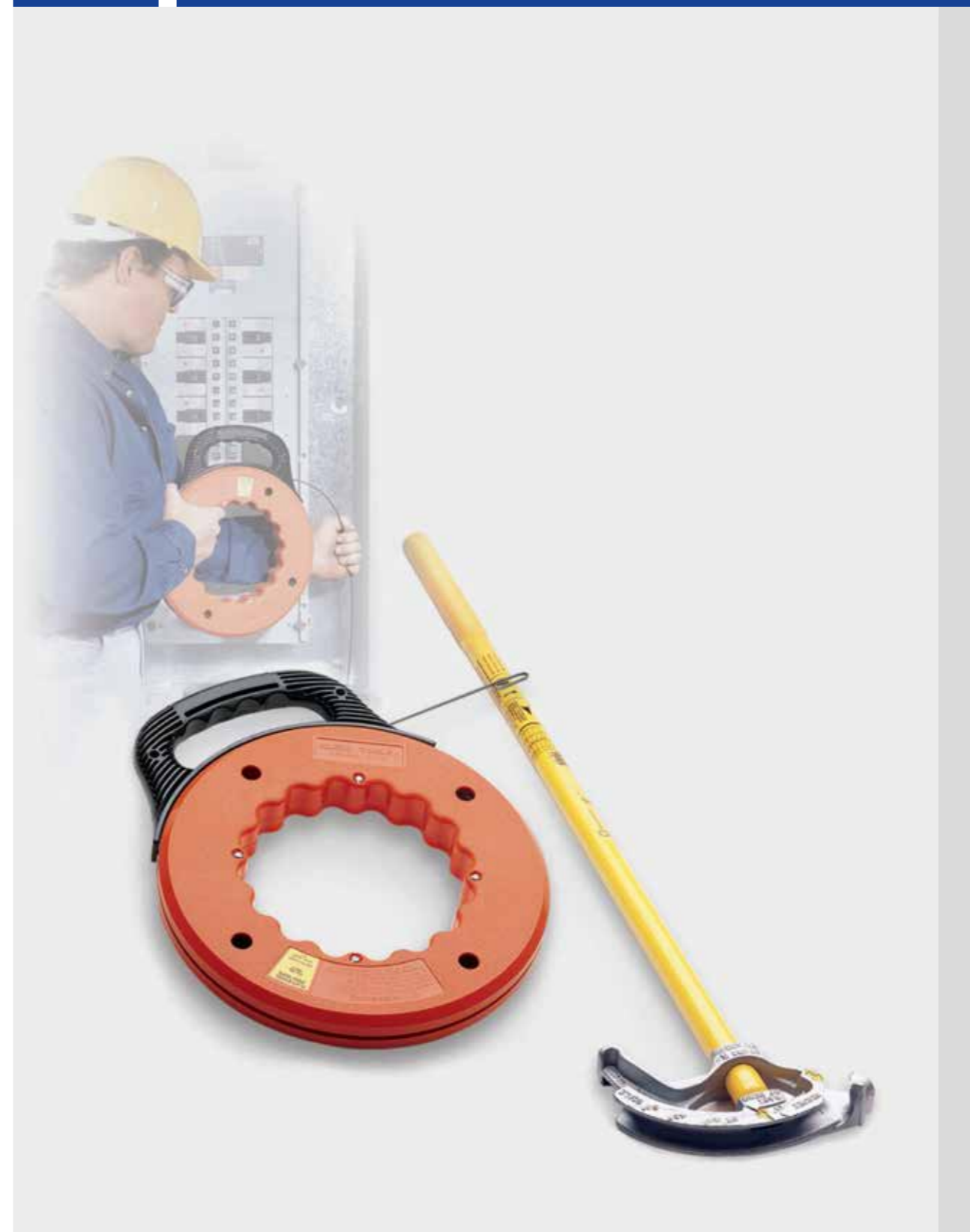



**Conduit Bender with Handle- Aluminum**

| Item No. | Conduit Size |
|----------|--------------|
|          | EMT          |
| ACB-050H | 1/2"         |
| ACB-075H | 3/4"         |
| ACB-100H | 1"           |

**Conduit Bender without Handle- Aluminum**



| Item No. | Conduit Size |
|----------|--------------|
|          | EMT          |
| ACB-050  | 1/2"         |
| ACB-075  | 3/4"         |
| ACB-100  | 1"           |

**Conduit Bender- Ductile Iron**



| Item No. | Conduit Size |
|----------|--------------|
|          | EMT          |
| SCB-050  | 1/2"         |
| SCB-075  | 3/4"         |
| SCB-100  | 1"           |
| SCB-125  | 1 1/4"       |

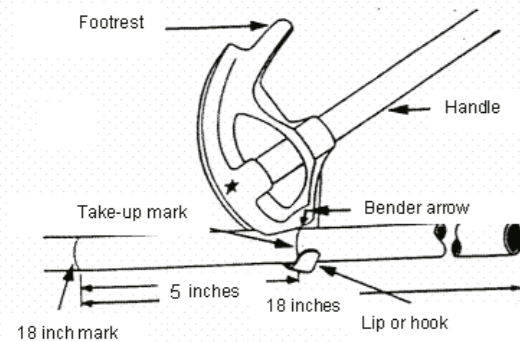

Natural Color / Zinc Plated

**Metal Cable Puller with Riveted Terminals A type**  
(Eyelet+Eyelet)

| Item No.            | Specification Width(mm) x Thickness(mm) | Length(m) |
|---------------------|---|-----------|
| MCP-3205A/MCP-5005A | 3.2 x 0.5/5.0x0.5                       | 5         |
| MCP-3210A/MCP-5010A | 3.2 x 0.5/5.0x0.5                       | 10        |
| MCP-3215A/MCP-5015A | 3.2 x 0.5/5.0x0.5                       | 15        |
| MCP-3220A/MCP-5020A | 3.2 x 0.5/5.0x0.5                       | 20        |
| MCP-3225A/MCP-5025A | 3.2 x 0.5/5.0x0.5                       | 25        |
| MCP-3230A/MCP-5030A | 3.2 x 0.5/5.0x0.5                       | 30        |



Natural Color / Zinc Plated

**Metal Cable Puller with Riveted Terminals B type**  
(Eyelet + Flex Metallic starting Spinner with Ball)

| Item No.            | Specification Width(mm) x Thickness(mm) | Length(m) |
|---------------------|---|-----------|
| MCP-3205B/MCP-5005B | 3.2 x 0.5/5.0x0.5                       | 5         |
| MCP-3210B/MCP-5010B | 3.2 x 0.5/5.0x0.5                       | 10        |
| MCP-3215B/MCP-5015B | 3.2 x 0.5/5.0x0.5                       | 15        |
| MCP-3220B/MCP-5020B | 3.2 x 0.5/5.0x0.5                       | 20        |
| MCP-3225B/MCP-5025B | 3.2 x 0.5/5.0x0.5                       | 25        |
| MCP-3230B/MCP-5030B | 3.2 x 0.5/5.0x0.5                       | 30        |



Natural Color / Zinc Plated

**Metal Cable Puller with Riveted Terminals C type**  
(Eyelet + Roller)

| Item No.            | Specification Width(mm) x Thickness(mm) | Length(m) |
|---------------------|---|-----------|
| MCP-3205C/MCP-5005C | 3.2 x 0.5/5.0x0.5                       | 5         |
| MCP-3210C/MCP-5010C | 3.2 x 0.5/5.0x0.5                       | 10        |
| MCP-3215C/MCP-5015C | 3.2 x 0.5/5.0x0.5                       | 15        |
| MCP-3220C/MCP-5020C | 3.2 x 0.5/5.0x0.5                       | 20        |
| MCP-3225C/MCP-5025C | 3.2 x 0.5/5.0x0.5                       | 25        |
| MCP-3230C/MCP-5030C | 3.2 x 0.5/5.0x0.5                       | 30        |

**Steel Spiral Cable Puller**

Small Roll with Brass Fixed Terminals (Spinner + Eyelet)



Natural Color / Zinc Plated

| Item No.  | Solid Diameter(mm) | Length(m) |
|-----------|--------------------|-----------|
| SSCP-3005 | Φ 3.2              | 5         |
| SSCP-3010 | Φ 3.2              | 10        |
| SSCP-3015 | Φ 3.2              | 15        |
| SSCP-3020 | Φ 3.2              | 20        |
| SSCP-3025 | Φ 3.2              | 25        |
| SSCP-3030 | Φ 3.2              | 30        |





### Nylon Cable Puller, Small Roll with Brass Fixed Terminals

(Flex starting Spinner with Ball and Eyelet on the back side of Fish Tape)

| Item No.          | Solid Diameter(mm) | Length(m) |
|-------------------|--------------------|-----------|
| NCP-3005/NCP-4005 | Φ3 / Φ4            | 5         |
| NCP-3010/NCP-4010 | Φ3 / Φ4            | 10        |
| NCP-3015/NCP-4015 | Φ3 / Φ4            | 15        |
| NCP-3020/NCP-4020 | Φ3 / Φ4            | 20        |
| NCP-3025/NCP-4025 | Φ3 / Φ4            | 25        |
| NCP-3030/NCP-4030 | Φ3 / Φ4            | 30        |



### Fiberglass Filling Cable Puller with Steel Fixed Terminals

(Eyelet+Eyelet)

| Item No. | Solid Diameter(mm) | Length(m) |
|----------|--------------------|-----------|
| FCP-4005 | Φ4.0               | 5         |
| FCP-4010 | Φ4.0               | 10        |
| FCP-4015 | Φ4.0               | 15        |
| FCP-4020 | Φ4.0               | 20        |
| FCP-4025 | Φ4.0               | 25        |
| FCP-4030 | Φ4.0               | 30        |



### Nylon Cable Puller, Small Roll with Brass Interchangeable Terminals

(Flex starting Spinner with Eyelet and Eyelet on the back side of Fish Tape)

| Item No.  | Solid Diameter(mm) | Length(m) |
|-----------|--------------------|-----------|
| NCP-4005D | Φ4                 | 5         |
| NCP-4010D | Φ4                 | 10        |
| NCP-4015D | Φ4                 | 15        |
| NCP-4020D | Φ4                 | 20        |
| NCP-4025D | Φ4                 | 25        |
| NCP-4030D | Φ4                 | 30        |



### More Rod Filling Cable Puller, Small Roll with Nickel Plated Brass Terminals

(Interchangeable Flex starting Spinner with Ball and Fixed Eyelet on the back side of Fish Tape)

| Item No.  | Solid Diameter(mm) | Length(m) |
|-----------|--------------------|-----------|
| MRCP-4005 | Φ4.0               | 5         |
| MRCP-4010 | Φ4.0               | 10        |
| MRCP-4015 | Φ4.0               | 15        |
| MRCP-4020 | Φ4.0               | 20        |
| MRCP-4025 | Φ4.0               | 25        |
| MRCP-4030 | Φ4.0               | 30        |



### Nylon Cable Puller with Brass Fixed Terminals

(Eyelet+Eyelet)

| Item No. | Solid Diameter(mm) | Length(m) |
|----------|--------------------|-----------|
| NCP-4505 | Φ4.5               | 5         |
| NCP-4510 | Φ4.5               | 10        |
| NCP-4515 | Φ4.5               | 15        |
| NCP-4520 | Φ4.5               | 20        |
| NCP-4525 | Φ4.5               | 25        |
| NCP-4530 | Φ4.5               | 30        |



### Single Rod Filling Cable Puller with Nickel Plated Brass Terminals

(Interchangeable Flex starting Spinner with Ball and Fixed Eyelet on the back side of Fish Tape)

| Item No.  | Solid Diameter(mm) | Length(m) |
|-----------|--------------------|-----------|
| SRCP-4005 | Φ4.0               | 5         |
| SRCP-4010 | Φ4.0               | 10        |
| SRCP-4015 | Φ4.0               | 15        |
| SRCP-4020 | Φ4.0               | 20        |
| SRCP-4025 | Φ4.0               | 25        |
| SRCP-4030 | Φ4.0               | 30        |



### Fiberglass Filling Cable Puller with Brass Fixed Terminals

(Flex starting Spinner with Ball and Eyelet on the back side of Fish Tape)

| Item No. | Solid Diameter(mm) | Length(m) |
|----------|--------------------|-----------|
| FCP-3005 | Φ3.0               | 5         |
| FCP-3010 | Φ3.0               | 10        |
| FCP-3015 | Φ3.0               | 15        |
| FCP-3020 | Φ3.0               | 20        |
| FCP-3025 | Φ3.0               | 25        |
| FCP-3030 | Φ3.0               | 30        |



### Twine Polyester Cable Puller with Galvanized Steel Terminals

(Flex starting Spinner with Eyelet and Eyelet on the back side of Fish Tape)

| Item No. | Solid Diameter(mm) | Length(m) |
|----------|--------------------|-----------|
| PCP-6010 | Φ6.0               | 10        |
| PCP-6015 | Φ6.0               | 15        |
| PCP-6020 | Φ6.0               | 20        |
| PCP-6025 | Φ6.0               | 25        |
| PCP-6030 | Φ6.0               | 30        |
| PCP-6050 | Φ6.0               | 50        |



\* Special Head for choose

### High Strength Steel Fish Wire Tap (Small Roll)

| Item No. | Specification<br>Width(mm) x Thickness(mm) | Length(m) |
|----------|--|-----------|
| NFWT-10S | 3.0 x 1.3                                  | 10        |
| NFWT-15S | 3.0 x 1.3                                  | 15        |
| NFWT-20S | 3.0 x 1.3                                  | 20        |
| NFWT-25S | 3.0 x 1.3                                  | 25        |
| NFWT-30S | 3.0 x 1.3                                  | 30        |



\* All kinds of Cable Puller available inside;  
\* Orange Shell for choose  
\* OEM also acceptable

### High Strength Steel Fish Wire Tap (Big Roll)

| Item No. | Specification<br>Width(mm) x Thickness(mm) | Length(m) |
|----------|--|-----------|
| FWT-30   | 3.0 x 1.3                                  | 30        |
| FWT-40   | 3.0 x 1.3                                  | 40        |
| FWT-45   | 3.0 x 1.3                                  | 45        |
| FWT-50   | 3.0 x 1.3                                  | 50        |
| FWT-60   | 3.0 x 1.3                                  | 60        |
| FWT-75   | 3.0 x 1.3                                  | 75        |
| FWT-100  | 3.0 x 1.3                                  | 100       |



\* All kinds of Cable Puller available inside;  
\* Special head for choose  
\* OEM also acceptable

### High Strength Steel Fish Wire Tap (Big Roll)

| Item No. | Specification<br>Width(mm) x Thickness(mm) | Length(m) |
|----------|--|-----------|
| NFWT-30  | 3.0 x 1.3                                  | 30        |
| NFWT-40  | 3.0 x 1.3                                  | 40        |
| NFWT-45  | 3.0 x 1.3                                  | 45        |
| NFWT-50  | 3.0 x 1.3                                  | 50        |
| NFWT-60  | 3.0 x 1.3                                  | 60        |
| NFWT-75  | 3.0 x 1.3                                  | 75        |
| NFWT-100 | 3.0 x 1.3                                  | 100       |

### Fiberglasss Cable Puller

| Item No. | Cable Puler Size<br>Width(mm) | Length(m) |
|----------|-------------------------------|-----------|
| D05L100  | 5.0                           | 100       |
| D11L050  | 11.0                          | 50        |
| D06L150  | 6.0                           | 150       |
| D14L050  | 14.0                          | 50        |

| Type | Wire Rack(cm)      | O.D. |
|------|--------------------|------|
| J1   | 40(L)x15(W)x50(H)  | 40CM |
| J2   | 55(L)x17(W)x64(H)  | 55CM |
| J3   | 65(L)x17(W)x73(H)  | 65CM |
| J4   | 90(L)x33(W)x100(H) | 90CM |

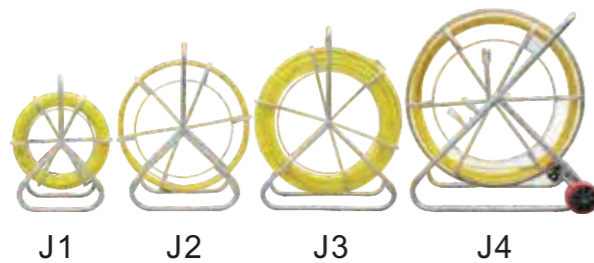

### Internal Bending Spring for Heavy Duty PVC Pipe

Finish: Natural,White Zinc Plated,Color Zinc Plated,Black Coating

| Item No.   | Size | Length(mm) |
|------------|------|------------|
| IBSH-16550 | 16   | 550        |
| IBSH-20550 | 20   | 550        |
| IBSH-25550 | 25   | 550        |
| IBSH-32550 | 32   | 550        |

Other size or length also available



### Internal Bending Spring for Medium PVC Pipe

Finish: Natural,White Zinc Plated,Color Zinc Plated,Black Coating

| Item No.   | Size | Length(mm) |
|------------|------|------------|
| IBSM-16550 | 16   | 550        |
| IBSM-20550 | 20   | 550        |
| IBSM-25550 | 25   | 550        |
| IBSM-32550 | 32   | 550        |

Other size or length also available



### Internal Bending Spring for Light Duty PVC Pipe

Finish: Natural,White Zinc Plated,Color Zinc Plated,Black Coating

| Item No.   | Size | Length(mm) |
|------------|------|------------|
| IBSL-16550 | 16   | 550        |
| IBSL-20550 | 20   | 550        |
| IBSL-25550 | 25   | 550        |
| IBSL-32550 | 32   | 550        |

Other size or length also available



### External Bending Spring for PVC Pipe

Finish: Natural,White Zinc Plated,Yellow Zinc Plated,Black Coating

| Item No.  | Size | Length(mm) |
|-----------|------|------------|
| EBS-16550 | 16   | 550        |
| EBS-20550 | 20   | 550        |
| EBS-25550 | 25   | 550        |
| EBS-32550 | 32   | 550        |

Other size or length also available

### Cable Glands

Material:  
Body: Nickel Plated Brass  
Seal: Polymeide 66  
Sealing: NBR  
IP68



### PG Thread

| Size   | Cable Diameter | Thread Length |
|--------|----------------|---------------|
| PG7    | 3-7            | 6             |
| PG9    | 4-8            | 7             |
| PG9    | 6-10           | 7             |
| PG11   | 6-10           | 7             |
| PG13.5 | 8-12           | 8             |
| PG13.5 | 4-8            | 8             |
| PG13.5 | 6-10           | 7             |
| PG13.5 | 10-14          | 8             |
| PG16   | 10-14          | 8             |
| PG16   | 8-12           | 8             |
| PG19   | 10-14          | 8             |
| PG21   | 13-18          | 8             |
| PG21   | 10-16          | 8             |
| PG25   | 13-18          | 8             |
| PG29   | 18-25          | 9             |
| PG36   | 25-32          | 10            |
| PG36   | 18-25          | 10            |
| PG42   | 32-38          | 10            |
| PG48   | 37-44          | 12            |
| PG63   | 43-52          | 15            |

### G Thread

| Size     | Cable Diameter | Thread Length |
|----------|----------------|---------------|
| G-1/4"   | 3-7            | 6             |
| G-3/8"   | 4-8            | 7             |
| G-3/8"   | 6-10           | 7             |
| G-1/2"   | 8-12           | 8             |
| G-1/2"   | 4-8            | 8             |
| G-1/2"   | 10-14          | 8             |
| G-3/4"   | 13-18          | 8             |
| G-1"     | 15-22          | 9             |
| G-1 1/4" | 22-28          | 10            |
| G-1 1/2" | 25-32          | 10            |
| G-1 1/2" | 18-25          | 10            |
| G-2"     | 37-44          | 12            |
| G-2 1/2" | 42-52          | 15            |
| G-3"     | 65-70          | 18            |

### NPT Thread

| Size   | Cable Diameter | Thread Length |
|--------|----------------|---------------|
| 1/4"   | 3-7            | 6             |
| 3/8"   | 4-8            | 7             |
| 1/2"   | 8-12           | 8             |
| 3/4"   | 13-18          | 8             |
| 1"     | 15-22          | 9             |
| 1 1/4" | 22-28          | 9             |
| 1 1/2" | 25-32          | 10            |
| 2"     | 37-44          | 12            |
| 2 1/2" | 42-52          | 15            |
| 3"     | 65-70          | 18            |

### Metric Thread

| Size        | Cable Diameter | Thread Length |
|-------------|----------------|---------------|
| M8*1.0      | 3-7            | 6             |
| M10*1.0     | 3-7            | 6             |
| M12*1.5     | 3-7            | 6             |
| M14*1.5     | 3-7            | 6             |
| M16*1.5     | 4-8            | 7             |
| M16*1.5     | 6-10           | 7             |
| M18*1.5     | 6-10           | 7             |
| M20*1.5     | 8-12           | 8             |
| M20*1.5     | 4-8            | 7             |
| M20*1.5     | 6-10           | 7             |
| M20*1.5     | 10-14          | 7             |
| M22*1.5     | 10-14          | 8             |
| M22*1.5     | 8-12           | 8             |
| M24*1.5     | 10-14          | 8             |
| M25*1.5     | 10-14          | 8             |
| M25*1.5     | 9-16           | 8             |
| M25*1.5     | 13-18          | 8             |
| M27*1.5(2)  | 13-18          | 8             |
| M27*1.5(2)  | 10-16          | 8             |
| M30*1.5(2)  | 13-18          | 8             |
| M30*1.5(2)  | 10-16          | 8             |
| M30*1.5(2)  | 15-20          | 8             |
| M32*1.5(2)  | 15-22          | 9             |
| M32*1.5(2)  | 13-18          | 8             |
| M32*1.5(2)  | 18-25          | 9             |
| M33*1.5(2)  | 15-22          | 9             |
| M36*1.5(2)  | 18-25          | 9             |
| M36*1.5(2)  | 15-22          | 9             |
| M37*1.5(2)  | 18-25          | 9             |
| M40*1.5(2)  | 22-28          | 10            |
| M40*1.5(2)  | 18-25          | 9             |
| M40*1.5(2)  | 22-30          | 10            |
| M40*1.5(2)  | 22-32          | 10            |
| M42*1.5(2)  | 22-28          | 10            |
| M42*1.5(2)  | 22-30          | 10            |
| M48*1.5(2)  | 25-32          | 10            |
| M50*1.5(2)  | 25-32          | 10            |
| M50*1.5(2)  | 32-38          | 12            |
| M54*1.5(2)  | 32-38          | 12            |
| M56*1.5(2)  | 32-38          | 12            |
| M60*1.5(2)  | 37-44          | 12            |
| M63*1.5(2)  | 37-44          | 12            |
| M63*1.5(2)  | 42-53          | 15            |
| M64*1.5(2)  | 37-44          | 12            |
| M72*1.5(2)  | 42-52          | 15            |
| M75*1.5(2)  | 42-52          | 15            |
| M76*1.5(2)  | 42-52          | 15            |
| M80*1.5(2)  | 50-62          | 16            |
| M85*1.5(2)  | 50-62          | 16            |
| M85*1.5(2)  | 60-70          | 18            |
| M88*1.5(2)  | 60-70          | 18            |
| M90*1.5(2)  | 60-70          | 18            |
| M100*1.5(2) | 70-80          | 20            |

### Plastic Cable Glands

Material: Nylon  
Color: grey or black  
IP67



### PG Thread

| Size   | Cable Diameter | Thread Length |
|--------|----------------|---------------|
| PG7    | 3-6.5          | 8/15          |
| PG7    | 2-5            | 8/15          |
| PG9    | 4-8            | 8/15          |
| PG9    | 2-6            | 8/15          |
| PG11   | 5-10           | 8/15          |
| PG11   | 3-7            | 8/15          |
| PG13.5 | 6-12           | 9/15          |
| PG13.5 | 5-9            | 9/15          |
| PG16   | 10-14          | 10/15         |
| PG16   | 7-12           | 10/15         |
| PG19   | 12-15          | 10            |
| PG19   | 10-12          | 10            |
| PG21   | 13-18          | 10/15         |
| PG21   | 9-16           | 10/15         |
| PG25   | 16-21          | 11            |
| PG25   | 13-18          | 11            |
| PG29   | 18-25          | 12/18         |
| PG29   | 13-20          | 12/18         |
| PG36   | 22-32          | 14/18         |
| PG36   | 20-26          | 14/18         |
| PG42   | 32-38          | 14/18         |
| PG42   | 25-31          | 14/18         |
| PG48   | 37-44          | 14/18         |
| PG48   | 29-35          | 14/18         |
| PG63   | 42-50          | 27            |

### Metric Thread

| Size    | Cable Diameter | Thread Length |
|---------|----------------|---------------|
| M12*1.5 | 3-6.5          | 8/15          |
| M12*1.5 | 2-5            | 8/15          |
| M16*1.5 | 4-8            | 8/15          |
| M16*1.5 | 2-6            | 8/15          |
| M18*1.5 | 5-10           | 8/15          |
| M18*1.5 | 3-7            | 8/15          |
| M20*1.5 | 6-12           | 9/15          |
| M20*1.5 | 5-9            | 9/15          |
| M20*1.5 | 10-14          | 15            |
| M20*1.5 | 7-12           | 15            |
| M22*1.5 | 10-14          | 10/15         |
| M22*1.5 | 7-12           | 10/15         |
| M24*1.5 | 12-15          | 10            |
| M24*1.5 | 10-12          | 10            |
| M25*1.5 | 13-18          | 10/15         |
| M25*1.5 | 9-16           | 10/15         |
| M27*1.5 | 13-18          | 10            |
| M27*1.5 | 9-16           | 10            |
| M30*1.5 | 16-21          | 11            |
| M30*1.5 | 13-18          | 11            |
| M32*1.5 | 16-21          | 11            |
| M32*1.5 | 13-18          | 11            |
| M36*1.5 | 18-25          | 12            |
| M36*1.5 | 13-20          | 12            |
| M40*1.5 | 22-32          | 14/18         |
| M40*1.5 | 20-26          | 14/18         |
| M50*1.5 | 32-38          | 14/18         |
| M50*1.5 | 25-31          | 14/18         |
| M63*1.5 | 37-44          | 14/18         |
| M63*1.5 | 29-35          | 14/18         |

### G / NPT Thread

| Size   | Cable Diameter | Thread Length |
|--------|----------------|---------------|
| 1/4"   | 3-6.5          | 8             |
| 3/8"   | 4-8            | 15            |
| 1/2"   | 6-12           | 13            |
| 3/4"   | 13-18          | 15            |
| 1"     | 18-25          | 16            |
| 1 1/4" | 18-25          | 18            |
| 1 1/2" | 22-32          | 15            |
| 2"     | 37-44          | 15            |

## Self-Locking Nylon Cable Ties

Color: Natural (or white, standard color)  
 UV Black and other colors are available as requested



## Terminal Blocks

Material: PA, PE or PP  
 Type: H, U(W), V(F)



| Item No  | L     | W    | H    | A    | B    | mm <sup>2</sup> | Volt | Amp  |
|----------|-------|------|------|------|------|-----------------|------|------|
| TBS-3A   | 90.3  | 15.5 | 10.8 | 6.0  | 8.0  | 4               | 400V | 3A   |
| TBS-5A   | 110.7 | 15.5 | 12.5 | 6.5  | 9.5  | 6               | 400V | 5A   |
| TBS-10A  | 117.5 | 20   | 15.0 | 8.4  | 10.5 | 10              | 400V | 10A  |
| TBS-16A  | 137.5 | 22   | 17.0 | 10.3 | 12.0 | 12              | 400V | 16A  |
| TBS-20A  | 155   | 25   | 19.2 | 11.5 | 13.5 | 14              | 400V | 20A  |
| TBS-30A  | 166.7 | 25.5 | 20.0 | 12.0 | 14.5 | 16              | 400V | 30A  |
| TBS-60A  | 188   | 29   | 23.5 | 13.5 | 16.5 | 25              | 400V | 60A  |
| TBS-80A  | 205   | 33   | 27.0 | 15.0 | 17.0 | 35              | 400V | 80A  |
| TBS-100A | 250   | 46   | 31.0 | 22.0 | 21.0 | 40              | 400V | 100A |

## Bus Bar Insulator, SM Type

with studs & locking washer or without



| Item No | Deep | Screw | Screw Depth | Tensile LBS | Voltage KV | Torgue LBS |
|---------|------|-------|-------------|-------------|------------|------------|
| SM-20S  | 20   | M5    | 7mm         | 300         | 5          | 4          |
| SM-25S  | 25   | M6    | 18mm        | 400         | 6          | 5          |
| SM-30S  | 30   | M8    | 11mm        | 550         | 8          | 8          |
| SM-35S  | 35   | M8    | 11mm        | 600         | 10         | 10         |
| SM-40S  | 40   | M8    | 11mm        | 650         | 12         | 12         |
| SM-45S  | 45   | M8    | 11mm        | 1000        | 14         | 20         |
| SM-51S  | 51   | M8    | 14mm        | 1000        | 15         | 20         |
| SM-60S  | 60   | M10   | 15mm        | 1200        | 20         | 35         |
| SM-76S  | 76   | M10   | 20mm        | 1500        | 25         | 40         |

| Item No.      | Length                            |      | Width | Bundle Dia. |
|---------------|-----------------------------------|------|-------|-------------|
|               | inch                              | mm   | mm    | mm          |
| SLCT-2.5x80   | 3 <sup>3</sup> / <sub>16</sub> "  | 80   | 2.5   | 2-16        |
| SLCT-2.5x100  | 4"                                | 100  | 2.5   | 2-22        |
| SLCT-2.5x120  | 4 <sup>3</sup> / <sub>4</sub> "   | 120  | 2.5   | 2-30        |
| SLCT-2.5x150  | 6"                                | 150  | 2.5   | 2-35        |
| SLCT-2.5x200  | 8"                                | 200  | 2.5   | 2-50        |
| SLCT-3.6x150  | 6"                                | 150  | 3.6   | 3-35        |
| SLCT-3.6x180  | 7"                                | 180  | 3.6   | 3-42        |
| SLCT-3.6x200  | 8"                                | 200  | 3.6   | 3-50        |
| SLCT-3.6x250  | 10"                               | 250  | 3.6   | 3-65        |
| SLCT-3.6x300  | 11 <sup>5</sup> / <sub>8</sub> "  | 300  | 3.6   | 3-80        |
| SLCT-3.6x370  | 14 <sup>1</sup> / <sub>2</sub> "  | 370  | 3.6   | 3-102       |
| SLCT-4.8x200  | 8"                                | 200  | 4.8   | 3-50        |
| SLCT-4.8x250  | 10"                               | 250  | 4.8   | 3-65        |
| SLCT-4.8x300  | 11 <sup>5</sup> / <sub>8</sub> "  | 300  | 4.8   | 3-80        |
| SLCT-4.8x350  | 13 <sup>3</sup> / <sub>4</sub> "  | 350  | 4.8   | 3-90        |
| SLCT-4.8x370  | 14 <sup>1</sup> / <sub>2</sub> "  | 370  | 4.8   | 3-102       |
| SLCT-4.8x400  | 15 <sup>3</sup> / <sub>4</sub> "  | 400  | 4.8   | 3-105       |
| SLCT-4.8x450  | 17 <sup>3</sup> / <sub>4</sub> "  | 450  | 4.8   | 3-130       |
| SLCT-4.8x500  | 19 <sup>1</sup> / <sub>16</sub> " | 500  | 4.8   | 3-150       |
| SLCT-7.6x200  | 8"                                | 200  | 7.6   | 3-50        |
| SLCT-7.6x250  | 10"                               | 250  | 7.6   | 4-65        |
| SLCT-7.6x300  | 11 <sup>5</sup> / <sub>8</sub> "  | 300  | 7.6   | 4-80        |
| SLCT-7.6x350  | 13 <sup>3</sup> / <sub>4</sub> "  | 350  | 7.6   | 4-90        |
| SLCT-7.6x380  | 15"                               | 380  | 7.6   | 4-100       |
| SLCT-7.6x400  | 15 <sup>3</sup> / <sub>4</sub> "  | 400  | 7.6   | 4-105       |
| SLCT-7.6x450  | 17 <sup>3</sup> / <sub>4</sub> "  | 450  | 7.6   | 4-110       |
| SLCT-7.6x500  | 19 <sup>1</sup> / <sub>16</sub> " | 500  | 7.6   | 4-150       |
| SLCT-7.6x550  | 21 <sup>1</sup> / <sub>16</sub> " | 550  | 7.6   | 4-160       |
| SLCT-7.6x700  | 27 <sup>1</sup> / <sub>2</sub> "  | 700  | 7.6   | 4-195       |
| SLCT-9.0x400  | 15 <sup>3</sup> / <sub>4</sub> "  | 400  | 9.0   | 8-105       |
| SLCT-9.0x450  | 17 <sup>3</sup> / <sub>4</sub> "  | 450  | 9.0   | 8-118       |
| SLCT-9.0x500  | 19 <sup>1</sup> / <sub>16</sub> " | 500  | 9.0   | 8-150       |
| SLCT-9.0x550  | 21 <sup>1</sup> / <sub>16</sub> " | 550  | 9.0   | 8-160       |
| SLCT-9.0x600  | 23 <sup>3</sup> / <sub>5</sub> "  | 600  | 9.0   | 8-170       |
| SLCT-9.0x650  | 25 <sup>9</sup> / <sub>16</sub> " | 650  | 9.0   | 8-185       |
| SLCT-9.0x720  | 27 <sup>1</sup> / <sub>2</sub> "  | 720  | 9.0   | 10-195      |
| SLCT-9.0x760  | 29 <sup>9</sup> / <sub>16</sub> " | 760  | 9.0   | 10-225      |
| SLCT-9.0x800  | 31 <sup>9</sup> / <sub>16</sub> " | 800  | 9.0   | 10-230      |
| SLCT-9.0x900  | 35 <sup>1</sup> / <sub>2</sub> "  | 900  | 9.0   | 10-265      |
| SLCT-9.0x1000 | 40 <sup>1</sup> / <sub>16</sub> " | 1000 | 9.0   | 10-300      |

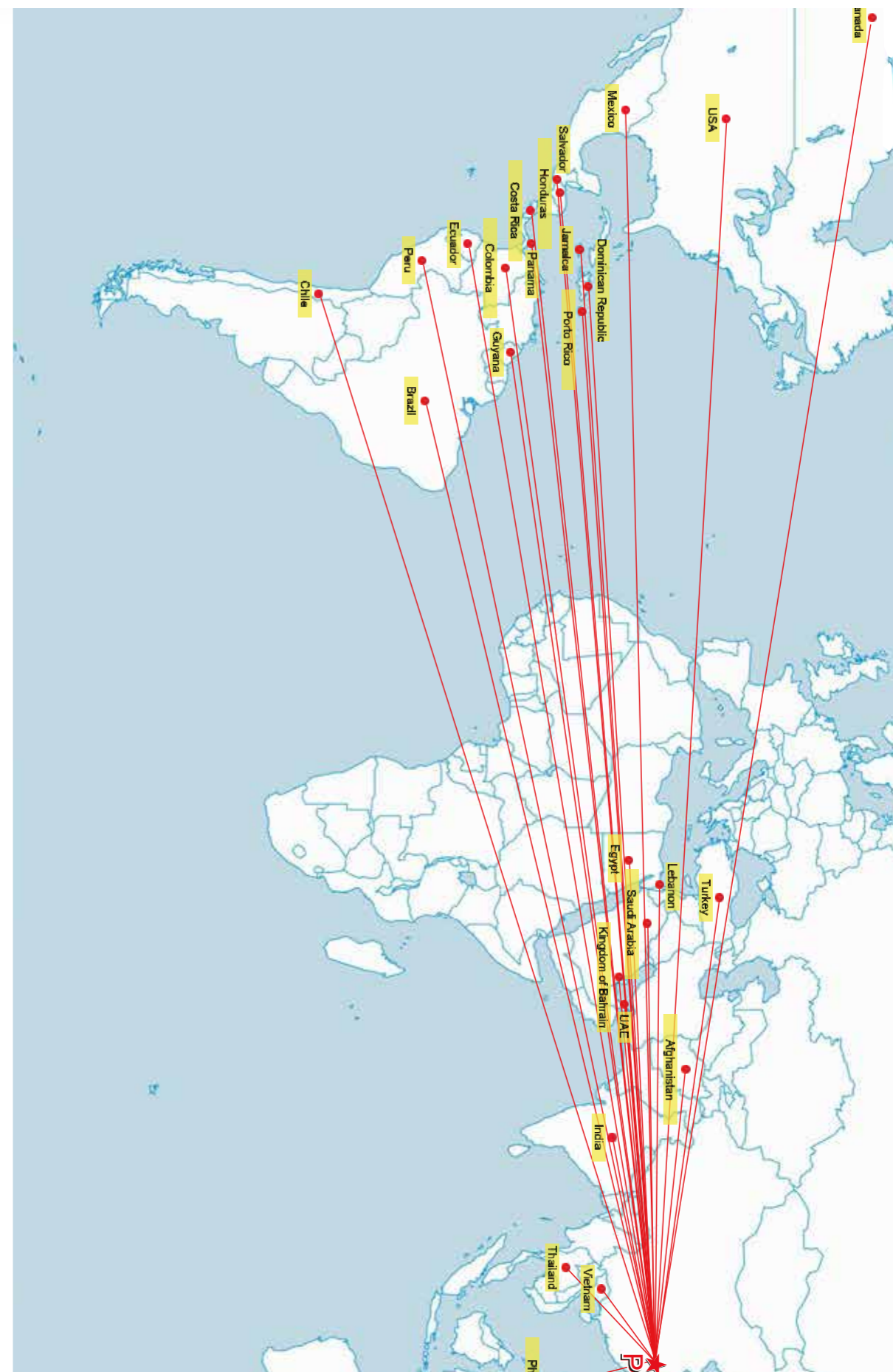

# **DUCTO MEX**

*AISLAMIENTOS INTELIGENTES*

JORGE ALBERTO RIOS  
BLVD. ALFONSO ZARAGOZA MAYTORENA  
#1980DESARROLLO URBANO TRES RÍOS  
C.P. 80020  
CULIACÁN, SINALOA  
DIRECCION@DUCTOSAISLADOS.COM  
(667) 207 7777